

# Level measurement

## Point level measurement – Vibrating switches

### SITRANS LVL200

#### Overview



SITRANS LVL200 is a standard vibrating level switch for use in liquid and slurry applications such as overflow, high, low, and demand applications, as well as pump protection. For use in SIL-2 applications.

#### Benefits

- Proven vibrating level switch technology for liquids
- Compact insertion length of 40 mm (1.57 inch) for confined space applications
- Fault monitoring for corrosion, loss of vibration or line break to the piezo drive
- Functional Safety (SIL 2). Device suitable for use in accordance with IEC 61508 and IEC 61511
- Hygienic process connections

#### Application

SITRANS LVL200 is a level switch designed for industrial use in all areas of process technology and can be used with liquids and slurries. With a tuning fork insertion length of only 40 mm (1.57 inch), SITRANS LVL200 can be mounted in small pipes and applications with confined space. The LVL200 can be used to measure products with a minimum density of  $> 0.5 \text{ g/cm}^3$  ( $0.018 \text{ lb/in}^3$ ). The LVL200 can be used in difficult conditions including turbulence, air bubbles, foam generation, buildup, or external vibration.

SITRANS LVL200 continuously monitors faults via frequency evaluation, providing early detection of strong corrosion or damage on the tuning fork, loss of vibration, or a line break to the piezo drive.

The tuning fork is piezoelectrically energized and vibrates at its mechanical resonance frequency of approximately 1 200 Hz. The vibration frequency changes when the tuning fork is covered by the medium. This change is detected by the integrated oscillator and converted into a switching command. The integrated electronics evaluate the level signal and output a switching signal, directly operating connected devices.

- Key Applications: For use in liquids and slurries, for level measurement, overflow, and dry run protection

#### Configuration

##### Horizontal mounting

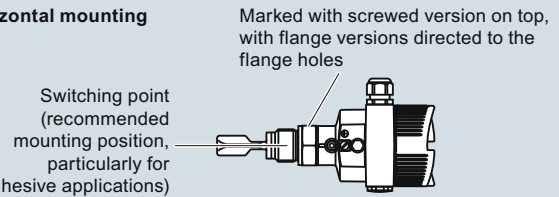

##### Vertical mounting

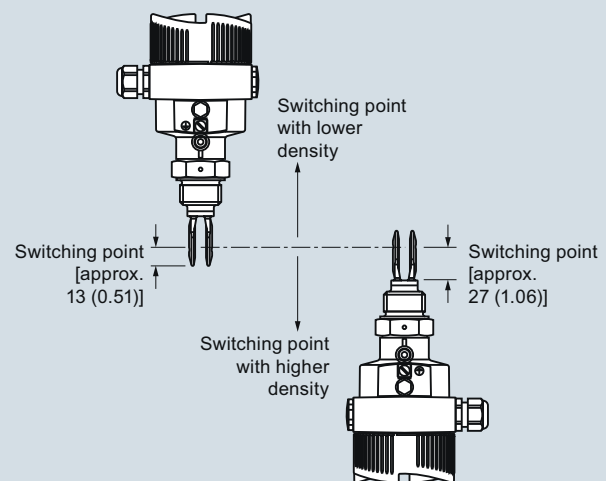

Mount away from filling openings or agitators.

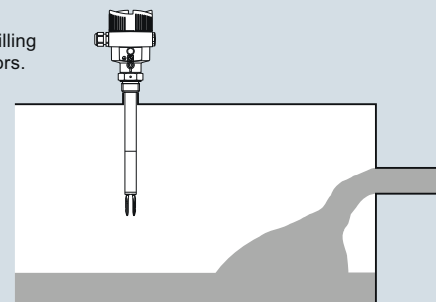

##### Moisture protection

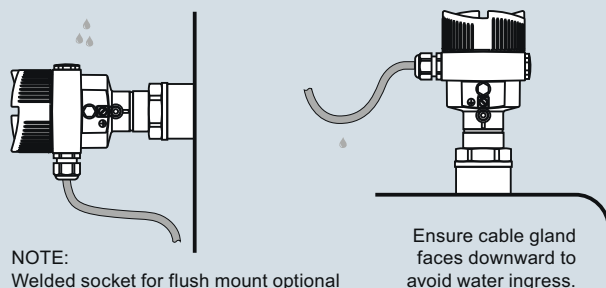

SITRANS LVL200 installation, dimensions in mm (inch)

# Level measurement

## Point level measurement – Vibrating switches

SITRANS LVL200

### Technical specifications

<b>Mode of operation</b>	
Measuring principle	Vibrating point level switch
<b>Input</b>	
Measured variable	High and low and demand (via mode switch)
<b>Output</b>	
Output options	<ul style="list-style-type: none"> <li>Relay output (DPDT), 2 floating SPDTs</li> <li>Contactless electronic switch</li> <li>2 wire Namur signal output</li> </ul>
<b>Measuring Accuracy</b>	
Repeatability	0.1 mm (0.004 inch)
Hysteresis	Approx. 2 mm (0.08 inch) with vertical installation
Switching delay	Approx. 500 ms (on/off)
Frequency	Approx. 1 200 Hz
<b>Rated operating conditions</b>	
Installation conditions	
• Location	Indoor/outdoor
Ambient conditions	
• Ambient temperature	-40 ... +70 °C (-40 ... +158 °F)
• Installation category	III
• Pollution degree	2
Medium conditions	
• Temperature	
- LVL200S Standard	-50 ... +150 °C (-58 ... +302 °F)
- LVL200S High temperature option	-50 ... +250 °C (-58 ... +482 °F)
- LVL200E Standard: with 316L/Hastelloy	-50 ... +150 °C (-58 ... +302 °F)
- LVL200E High temperature option: with 316L/Hastelloy	-50 ... +250 °C (-58 ... +482 °F)
• Pressure (vessel)	-1 ... 64 bar g (-14.5 ... 928 psi g)
• Density	0.7 ... 2.5 g/cm <sup>3</sup> (0.025 ... 0.09 lb/in <sup>3</sup> ); 0.5 ... 2.5 g/cm <sup>3</sup> (0.018 ... 0.09 lb/in <sup>3</sup> ) by switching over
<b>Design</b>	
Material	
• Enclosure	Aluminum die-cast AISI10Mg, powder-coated, basis: Polyester stainless steel housing, electropolished 316L
• Tuning fork	316L (1.4404 or 1.4435), Hastelloy
• Extension tube [ø 21.3 mm (0.839 inch)]	316L (1.4404 or 1.4435), Hastelloy
• Process connection: threaded	316L (1.4404 or 1.4435), Hastelloy
• Process connection: flange	316L (1.4404 or 1.4435), 316L with Hastelloy, ECTFE, or PFA coating Klingersil C-4400
• Process seal	
Process connection	
• Pipe thread, cylindrical (ISO 228 T1)	G ¾" A, G 1" A
• Pipe thread, tapered	¾" NPT, 1" NPT, 1½" NPT
• Flanges	DIN from DN 25, ANSI from 1"
• Hygienic fittings	Bolting DN 40 PN 40, 1, 1½, 2, 2½" Tri-Clamp PN 10, conus DN 25 PN 40, Tuchenhausen Vari-vent DN 50 PN 10, SMS

Degree of protection	Type 4X/NEMA 4X/IP66/IP67
Conduit entry	<ul style="list-style-type: none"> <li>1 x M20x1.5 (cable: ø5 ... 9 mm), 1 x blind stopper M20x1.5; attached 1 x M20x1.5 cable entry</li> <li>1 x ½" NPT cable entry, 1 x blind stopper ½" NPT, 1 x ½" NPT cable entry</li> <li>1 x M12x1; 1 x blind stopper M20x1.5</li> </ul>
Weight	
• Device weight (dependent on process fitting)	Approx. 0.8 ... 4 kg (0.18 ... 8.82 lb)
• Tube extension (extended version)	Approx. 920 g/m (10 oz/ft)
<b>Power supply</b>	
Supply voltage	
• Relay DPDT	20 ... 253 V AC, 50/60 Hz, 20 ... 72 V DC [at U>60 V DC]
• Contactless	20 ... 253 V AC, 50/60 Hz, 20 ... 253 V DC
• 2 wire NAMUR	
Operating voltage (characteristics according to standard) for connection to an amplifier according to NAMUR	IEC 60947-5-6, approx. 8.2 V Off-load voltage U <sub>0</sub> approx. 8.2 V Short-circuit current I <sub>J</sub> approx. 8.2 mA
Power consumption	
• Relay DPDT	1 ... 8 VA AC, approx. 1.3 W DC
• Contactless	1 ... 8 VA AC, approx. 1.3 W DC
• 2 wire Namur	
	Domestic current requirement approx. 3 mA (via load circuit)
	Load current
	- Min. 10 mA
	- Max. 400 mA [with I > 300 mA the ambient temperature can be max. 60 °C (140 °F)]
	- Max. 4 A up to 40 ms (not WHG specified)
	Current consumption
	- Falling characteristics
	≥ 2.6 mA uncovered/≤ 0.6 mA covered
	- ≤ 0.6 mA uncovered/≥ 2.6 mA covered
	- Failure message ≤ 0.6 mA
<b>Certificates and approvals</b>	
	<ul style="list-style-type: none"> <li>CE, CSA</li> <li>Overfill Protection WHG and VLAREM II</li> <li>FM (Non-Incendive) Class I, Div. 2, Groups A, B, C, D</li> <li>FM (Explosion-Proof) Class I, Div. 1, Groups A, B, C, D; (Dust Ignition-Proof) Class II, III, Div. 1, Groups E, F, G1)</li> <li>IECEX d IIC T6...T2 Ga/Gb EHEDG</li> <li>ATEX II 1/2G, 2G EEx d IIC T6</li> <li>ATEX II 1G, 1/2G, 2G EEx ia IIC T6</li> </ul>
	Shipping approvals
	• BR-Ex d IIC T6...T2
	• FDA, 3A, Ehedge
	• SIL/IEC61508 Declaration of Conformity [SIL-2 (min/max detection)]

4

# Level measurement

## Point level measurement – Vibrating switches

### SITRANS LVL200

#### Selection and Ordering data

Article No.



#### SITRANS LVL200, Standard

Compact vibrating level switch for use in liquid and slurry applications such as overflow, high, low, and demand applications, as well as pump protection. For use in SIL-2 and hazardous applications.

















7ML5746-

A 0

#### Electronics

Contactless electronic switch 20...250 V AC/DC  **1**  
 Double relay (DPDT) 20 ... 72 V DC/20 ... 250 V AC  **2**  
 NAMUR signal<sup>1)</sup>  **4**

#### Approvals

Without approvals  **A**  
 Overfill protection (WHG)  **B**  
 ATEX II 1G, 1/2G, 2G EEx ia IIC T6 + WHG <sup>2)</sup>  **C**  
 ATEX II 1/2G, 2G EEx d IIC T6 + WHG <sup>3)</sup>  **D**  
 ATEX II 1G, 1/2G, 2G EEx ia IIC T6 + shipping approvals<sup>2)</sup>  **E**  
 ATEX II 1/2G, 2G EEx d IIC T6 + shipping approvals<sup>3)</sup>  **F**  
 ATEX II 1G, 1/2G, 2G EEx ia IIC T6 + ATEX II 1/2 D IP6X T<sup>2)</sup>  **G**  
 IECEx Ex ia IIC T6<sup>2)</sup>  **H**  
 Shipping approvals  **K**  
 FM (IS) Class I, II, III, Div. 1, Groups A, B, C, D, E, F, G <sup>2)4)</sup>  **N**  
 FM (XP) Class I, Div. 1, Groups A, B, C, D; (DIP) Class II, III, Div. 1, Groups E, F, G<sup>3)4)</sup>  **P**  
 FM (NI) Class I, Div. 2, Groups A, B, C, D<sup>4)</sup>  **Q**  
 IECEx d IIC T6...T2 Ga/Gb  **R**  
 CSA(XP)CL I, II, III DIV 1, Groups A, B, C, D, E, F, G  **S**  
 CSA(NI)CL I, II, III, DIV 2, Groups A, B, C, D, E, F, G  **T**  
 BR-Ex d IIC T6...T2  **U**  
 CSA(IS)CL I, II, III DIV 1, Groups A, B, C, D, E, F, G  **V**

#### Process connection

Thread G<sup>3</sup>/<sub>4</sub>" A, PN 64/316L  **A 0 0**  
 Thread G<sup>3</sup>/<sub>4</sub>" A, PN 64/316L Ra < 0.8 µm  **A 0 1**  
 Thread <sup>3</sup>/<sub>4</sub>" NPT, PN 64/316L  **A 0 2**  
 Thread <sup>3</sup>/<sub>4</sub>" NPT, PN 64/316L Ra < 0.8 µm  **A 0 3**  
 Thread <sup>3</sup>/<sub>4</sub>" NPT, PN 64/Monel  **A 0 4**  
 Thread G<sup>3</sup>/<sub>4</sub>" A, PN 64/Hastelloy  **A 0 5**  
 Thread <sup>3</sup>/<sub>4</sub>" NPT, PN 64/Hastelloy  **A 0 6**  
 Thread G1" A, PN 64/316L  **A 0 7**  
 Thread G1" A, PN 64/316L ECTFE coated MB1982<sup>5)</sup>  **A 0 8**  
 Thread G1" A, PN 64/316L PFA coated<sup>5)</sup>  **A 1 0**  
 Thread G1" A, PN 64/Monel  **A 1 1**  
 Thread G1" A, PN 64 / 316L Ra<0.8µm  **A 1 2**  
 Thread G1" A, PN 64/316L Ra < 0.8 µm  **A 1 3**  
 Thread 1" NPT, PN 64/316L<sup>5)</sup>  **A 1 4**  
 Thread 1" NPT, PN 64/316L ECTFE coated MB1982<sup>5)</sup>  **A 1 5**  
 Thread 1" NPT, PN 64/316L PFA-coated  **A 1 6**  
 Thread 1" NPT, PN 64/Monel  **A 1 7**  
 Thread 1" NPT, PN 64/316L Ra < 0.8 µm  **A 1 8**  
 Thread G1" A, PN 64/Hastelloy  **A 2 0**  
 Thread G1<sup>1</sup>/<sub>2</sub>" A, PN 64/316L  **A 2 1**  
 Thread G1<sup>1</sup>/<sub>2</sub>" A, PN 64/316L Ra<0,8µm  **A 2 2**  
 Thread G1<sup>1</sup>/<sub>2</sub>" A, PN 64/Hastelloy  **A 2 3**  
 Thread 1" NPT, PN 64/Hastelloy  **A 2 4**  
 Thread 1<sup>1</sup>/<sub>2</sub>" NPT, PN 64/316L  **A 2 5**  
 Thread 1<sup>1</sup>/<sub>2</sub>" NPT, PN 64/316L Ra<0,8µm  **A 2 6**  
 Thread 1<sup>1</sup>/<sub>2</sub>" NPT, PN 64/Hastelloy  **A 2 7**  
 Thread G2" A, PN 64/316L  **A 2 8**  
 Thread M27x1.5, PN 64/316L  **A 3 0**  
 Conus DN 25, PN 40/316L Ra < 0.3 µm  **A 3 1**  
 Conus DN 25, PN 40/316L Ra < 0.8 µm  **A 3 2**  
 Conus DN 25, PN 40/ECTFE (ZB3033)<sup>5)</sup>  **A 3 3**  
 Conus M52, PN 40/316L  **A 3 4**  
 Conus M52, PN 40/316L Ra < 0.3 µm  **A 3 5**

#### Selection and Ordering data























































Article No.

#### SITRANS LVL200, Standard

Compact vibrating level switch for use in liquid and slurry applications such as overflow, high, low, and demand applications, as well as pump protection. For use in SIL-2 and hazardous applications.

7ML5746-



A 0

Conus M52, PN 40/316L Ra < 0.8 µm  **A 3 6**  
 Tri-Clamp 1", PN 16/316L Ra < 0.3 µm  **A 3 7**  
 Tri-Clamp 1", PN 16/Hastelloy  **A 3 8**  
 Tri-Clamp 1", PN 16/316L Ra < 0.8 µm  **A 4 0**  
 Tri-Clamp 1<sup>1</sup>/<sub>2</sub>", PN 16/316L Ra < 0.3 µm  **A 4 1**  
 Tri-Clamp 1<sup>1</sup>/<sub>2</sub>", PN 16/Hastelloy  **A 4 2**  
 Tri-Clamp 1<sup>1</sup>/<sub>2</sub>", PN 16/316L Ra < 0.8 µm  **A 4 3**  
 Tri-Clamp 2", PN 16/316L Ra < 0.3 µm  **A 4 4**  
 Tri-Clamp 2", PN 16/Hastelloy  **A 4 5**  
 Tri-Clamp 2", PN 16/316L Ra < 0.8 µm  **A 4 6**  
 Tri-Clamp 2<sup>1</sup>/<sub>2</sub>", PN 10/316L Ra < 0.3 µm  **A 4 7**  
 Tri-Clamp 2<sup>1</sup>/<sub>2</sub>", PN 10/316L Ra < 0.8 µm  **A 4 8**  
 Tri-Clamp 3", PN 10/316L Ra < 0.3 µm  **A 5 0**  
 Tri-Clamp 3", PN 10/316L Ra < 0.8 µm  **A 5 1**  
 Bolting DN 32, PN 40 DIN11851/316L Ra < 0.3 µm  **A 5 2**  
 Bolting DN 32, PN 40 DIN11851/316L Ra < 0.8 µm  **A 5 3**  
 Bolting DN 25, PN 40 DIN11851/316L Ra < 0.3 µm  **A 5 4**  
 Bolting DN 25, PN 40 DIN11851/316L Ra < 0.8 µm  **A 5 5**  
 Bolting DN 40, PN 40 DIN11851/316L Ra < 0.3 µm  **A 5 6**  
 Bolting DN 40, PN 40 DIN11851/316L Ra < 0.8 µm  **A 5 7**  
 Bolting DN 40, PN 40 DIN11864-1 A/316L Ra < 0.8 µm ZB3052  **A 5 8**  
 Bolting DN 50, PN 25 DIN11851/316L Ra < 0.3 µm  **A 6 0**  
 Bolting DN 50, PN 25 DIN11851/316L Ra < 0.8 µm  **A 6 1**  
 Bolting DN 50, PN 25 DIN11864-1 A/316L Ra < 0.8 µm ZB3052  **A 6 2**  
 Hygienic w. compr. nut F40, PN 25/316L  **A 6 3**  
 Hygienic w. compr. nut F40, PN 25/316L Ra < 0.3 µm  **A 6 4**  
 Hygienic w. compr. nut F40, PN 25/316L Ra < 0.8 µm  **A 6 5**  
 Varivent N50-40/316L Ra < 0.3 µm  **A 6 6**  
 Varivent N50-40/316L Ra < 0.8 µm  **A 6 7**  
 Varivent N125/100/316L Ra < 0.8 µm  **A 6 8**  
 DRD flange, PN 40/316L ZB3007  **A 7 0**  
 SMS DN 38/316L Ra < 0.8 µm<sup>5)</sup>  **A 7 1**  
 SMS DN 51, PN 6/316L Ra < 0.8 µm<sup>5)</sup>  **A 7 2**  
 Swagelok VCR screwing ZG2579, PN 64/316L  **A 7 3**  
 Neumo biocontrol size 25, PN 16/316L Ra < 0.8 µm  **A 7 4**  
 Neumo biocontrol size 50, PN 16/316L Ra < 0.8 µm<sup>5)</sup>  **A 7 5**  
 Neumo biocontrol size 65, PN 16/316L Ra < 0.8 µm  **A 7 6**  
 Neumo biocontrol size 80, PN 16/316L Ra < 0.8 µm  **A 7 7**  
 SÜDMO DN 50, PN 10/316L Ra<0,8µm  **A 7 8**  
 Small flange DN 25, PN 1.5 DIN 28403/316L pol. Ra < 0.8 µm  **A 8 0**  
 Small flange DN 40, PN 1.5 DIN 28403/316L pol. Ra < 0.8 µm  **A 8 1**  
 Ingold connection, PN 16/316L Ra < 0.8 µm  **A 8 2**  
 Ingold connection, PN 16/Hastelloy  **A 8 3**  
 Terminal DN 33.7 PN 40 DIN11864-3-A-/316L BN2 Ra < 0.8 µm<sup>5)</sup>  **A 8 4**  
 Hygienic fl. DN 50 PN 16 DIN11864-2-A-/316L Ra < 0.8 µm  **A 8 5**  
 Flange DN 25, PN 6 Form C, DIN 2501/316L  **A 8 6**  
 Flange DN 25, PN 6 Form C, DIN 2501/PFA<sup>5)</sup>  **A 8 7**  
 Flange DN 25, PN 40 Form C, DIN 2501/316L  **A 8 8**  
 Flange DN 25, PN 40 Form C, DIN 2501/Hastelloy  **B 0 0**  
 Flange DN 25, PN 40 Form C, DIN 2501/ECTFE<sup>5)</sup>  **B 0 1**  
 Flange DN 25, PN 40 Form C, DIN 2501/PFA<sup>5)</sup>  **B 0 2**  
 Flange DN 25, PN 40 Form C, DIN 2501/Enamelled  **B 0 3**  
 Flange DN 25, PN 40 Form D, DIN 2501/316L  **B 0 4**  
 Flange DN 25, PN 40 Form F, DIN 2501/316L  **B 0 5**

# Level measurement

## Point level measurement – Vibrating switches

SITRANS LVL200

Selection and Ordering data	Article No.	Selection and Ordering data	Article No.
<b>SITRANS LVL200, Standard</b> Compact vibrating level switch for use in liquid and slurry applications such as overflow, high, low, and demand applications, as well as pump protection. For use in SIL-2 and hazardous applications.	<b>7ML5746-</b> 	<b>SITRANS LVL200, Standard</b> Compact vibrating level switch for use in liquid and slurry applications such as overflow, high, low, and demand applications, as well as pump protection. For use in SIL-2 and hazardous applications.	<b>7ML5746-</b> 
Flange DN 25, PN 40 Form N, DIN 2501/316L	<b>B 06</b>	Flange DN 100, PN 16 Form F, DIN 2501/316L	<b>B 68</b>
Flange DN 25, PN 40 Form N, DIN 2501/Hastelloy	<b>B 07</b>	Flange DN 100, PN 16 Form N, DIN 2501/316L	<b>B 70</b>
Flange DN 25, PN 40 Form N, DIN 2501/Monel solid	<b>B 08</b>	Flange DN 100, PN 40 Form C, DIN 2501/316L	<b>B 71</b>
Flange DN 25, PN 40 V13, DIN 2501/316L	<b>B 10</b>	Flange DN 100, PN 40 Form C, DIN 2501/ECTFE <sup>5)</sup>	<b>B 72</b>
Flange DN 32, PN 40 Form C, DIN 2501/316L	<b>B 11</b>	Flange DN 100, PN 40 Form C, DIN 2501/PFA <sup>5)</sup>	<b>B 73</b>
Flange DN 32, PN 40 Form C, DIN 2501/ECTFE <sup>5)</sup>	<b>B 12</b>	Flange DN 100, PN 40 Form C, DIN 2501/Enamelled <sup>6)</sup>	<b>B 74</b>
Flange DN 40, PN 6 Form C, DIN 2501/316L	<b>B 13</b>	Flange DN 100, PN 40 Form F, DIN 2501/316L	<b>B 75</b>
Flange DN 40, PN 6 Form C, DIN 2501/ECTFE <sup>5)</sup>	<b>B 14</b>	Flange DN 100, PN 40 Form N, DIN 2501/316L	<b>B 76</b>
Flange DN 40, PN 40 Form C, DIN 2501/316L	<b>B 15</b>	Flange DN 100, PN 40 V13, DIN 2501/316L	<b>B 77</b>
Flange DN 40, PN 40 Form C, DIN 2501/Hastelloy	<b>B 16</b>	Flange DN 100, PN 64 Form E, DIN 2501/316L	<b>B 78</b>
Flange DN 40, PN 40 Form C, DIN 2501/ECTFE <sup>5)</sup>	<b>B 17</b>	Flange DN 100, PN 100 Form E, DIN 2501/316L	<b>B 80</b>
Flange DN 40, PN 40 Form C, DIN 2501/PFA <sup>5)</sup>	<b>B 18</b>	Flange DN 100, PN 100 Form L, DIN 2501/316L	<b>B 81</b>
Flange DN 40, PN 40 Form C, DIN 2501/Enamelled <sup>6)</sup>	<b>B 20</b>	Flange DN 125, PN 16 Form F, DIN 2501/316L	<b>B 82</b>
Flange DN 40, PN 40 Form F, DIN 2501/316L	<b>B 21</b>	Flange DN 125, PN 40 Form C, DIN 2501/316L	<b>B 83</b>
Flange DN 40, PN 40 Form N, DIN 2501/316L	<b>B 22</b>	Flange DN 125, PN 40 Form N, DIN 2512/316L	<b>B 84</b>
Flange DN 40, PN 40 Form E, DIN 2501/316L	<b>B 23</b>	Flange DN 150, PN 16 Form C, DIN 2501/316L	<b>B 85</b>
Flange DN 40, PN 40 V13, DIN 2501/316L	<b>B 24</b>	Flange DN 150, PN 16 Form C, DIN 2501/Hastelloy	<b>B 86</b>
Flange DN 50, PN 40 Form C, DIN 2501/316L	<b>B 25</b>	Flange DN 150, PN 16 Form C, DIN 2501/ECTFE <sup>5)</sup>	<b>B 87</b>
Flange DN 50, PN 40 Form C, DIN 2501/Hastelloy	<b>B 26</b>	Flange DN 150, PN 16 Form C, DIN 2501/PFA <sup>5)</sup>	<b>B 88</b>
Flange DN 50, PN 40 Form C, DIN 2501/ECTFE <sup>5)</sup>	<b>B 27</b>	Flange DN 150, PN 16 Form D, DIN 2501/316L	<b>C 00</b>
Flange DN 50, PN 40 Form C, DIN 2501/ECTFE (ZB3108) <sup>5)</sup>	<b>B 28</b>	Flange DN 150, PN 40 Form C, DIN 2501/316L	<b>C 01</b>
Flange DN 50, PN 40 Form C, DIN 2501/PFA <sup>5)</sup>	<b>B 30</b>	Flange DN 150, PN 40 Form C, DIN 2501/Hastelloy	<b>C 02</b>
Flange DN 50, PN 40 Form D, DIN 2501/316L	<b>B 31</b>	Flange DN 150, PN 40 Form F, DIN 2501/316L	<b>C 03</b>
Flange DN 50, PN 40 Form D, DIN 2501/Hastelloy	<b>B 32</b>	Flange DN 150, PN 40 Form N, DIN 2512/316L	<b>C 04</b>
Flange DN 50, PN 40 Form F, DIN 2501/316L	<b>B 33</b>	Flange DN 200, PN 10 Form C, DIN 2501/ECTFE <sup>5)</sup>	<b>C 05</b>
Flange DN 50, PN 40 Form N, DIN 2501/316L	<b>B 34</b>	Flange DN 200, PN 16 Form C, DIN 2501/316L	<b>C 06</b>
Flange DN 50, PN 40 Form N, DIN 2501/Hastelloy	<b>B 35</b>	Flange DN 25, PN 40 Form B1, EN 1092-1/316L	<b>C 07</b>
Flange DN 50, PN 40 Form E, DIN 2501/316L	<b>B 36</b>	Flange DN 25, PN 40 Form B1, EN 1092-1/Hastelloy	<b>C 08</b>
Flange DN 50, PN 40 V13, DIN 2501/316L	<b>B 37</b>	Flange DN 25, PN 40 Form B1, EN/316L/PFA <sup>5)</sup>	<b>C 10</b>
Flange DN 50, PN 40 R13, DIN 2501/316L	<b>B 38</b>	Flange DN 25, PN 40 Form B1, EN 1092-1/Enamelled <sup>6)</sup>	<b>C 11</b>
Flange DN 50, PN 64 Form F, DIN 2501/316L	<b>B 40</b>	Flange DN 25, PN 40 Form B2, EN 1092-1/316L	<b>C 12</b>
Flange DN 50, PN 64 Form N, DIN 2501/Hastelloy	<b>B 41</b>	Flange DN 25, PN 40 Form F, EN 1092-1/316L	<b>C 13</b>
Flange DN 50, PN 64 Form C, DIN 2501/316L	<b>B 42</b>	Flange DN 25, PN 63 Form B1, EN 1092-1/316L	<b>C 14</b>
Flange DN 50, PN 64 Form L, DIN 2501/316L	<b>B 43</b>	Flange DN 25, PN 100 Form B2, EN 1092-1/316L	<b>C 15</b>
Flange DN 50, PN 100 Form E, DIN 2501/316L	<b>B 44</b>	Flange DN 40, PN 40 Form B1, EN/316L	<b>C 16</b>
Flange DN 50, PN 100 Form L, DIN 2501/316L	<b>B 45</b>	Flange DN 40, PN 40 Form B1, EN 1092-1/PFA <sup>5)</sup>	<b>C 17</b>
Flange DN 65, PN 40 Form C, DIN 2501/316L	<b>B 46</b>	Flange DN 40, PN 40 Form B2, EN/316L	<b>C 18</b>
Flange DN 65, PN 40 Form C, DIN 2501/Hastelloy	<b>B 47</b>	Flange DN 50, PN 40 Form B1, EN/316L	<b>C 20</b>
Flange DN 65, PN 40 Form C, DIN 2501/ECTFE <sup>5)</sup>	<b>B 48</b>	Flange DN 50, PN 40 Form B1, EN 1092-1/Hastelloy	<b>C 21</b>
Flange DN 65, PN 40 Form C, DIN 2501/PFA <sup>5)</sup>	<b>B 50</b>	Flange DN 50, PN 40 Form B1, EN 1092-1/Monel ZB2977	<b>C 22</b>
Flange DN 65, PN 40 Form F, DIN 2501/316L	<b>B 51</b>	Flange DN 50, PN 40 Form B1, EN 1092-1/ECTFE <sup>5)</sup>	<b>C 23</b>
Flange DN 65, PN 64 Form E, DIN 2501/316L	<b>B 52</b>	Flange DN 50, PN 40 Form B1, EN/316L/PFA <sup>5)</sup>	<b>C 24</b>
Flange DN 80, PN 40 Form C, DIN 2501/316L	<b>B 53</b>	Flange DN 50, PN 40 Form B1, EN 1092-1/Enamelled <sup>6)</sup>	<b>C 25</b>
Flange DN 80, PN 40 Form C, DIN 2501/Hastelloy	<b>B 54</b>	Flange DN 50, PN 40 Form C, EN 1092-1/316L	<b>C 26</b>
Flange DN 80, PN 40 Form C, DIN 2501/ECTFE <sup>5)</sup>	<b>B 55</b>	Flange DN 50, PN 40 Form D, EN/316L	<b>C 27</b>
Flange DN 80, PN 40 Form C, DIN 2501/PFA <sup>5)</sup>	<b>B 56</b>	Flange DN 50, PN 40 Form D, EN 1092-1/Hastelloy	<b>C 28</b>
Flange DN 80, PN 40 Form C, DIN 2501/Enamelled <sup>6)</sup>	<b>B 57</b>	Flange DN 50, PN 40 Form B2, EN 1092-1/316L	<b>C 30</b>
Flange DN 80, PN 40 Form F, DIN 2501/316L	<b>B 58</b>	Flange DN 50, PN 40 Form E, EN 1092-1/316L	<b>C 31</b>
Flange DN 80, PN 40 Form N, DIN 2501/316L	<b>B 60</b>	Flange DN 80, PN 40 Form B1, EN 1092-1/316L	<b>C 32</b>
Flange DN 100, PN 16 Form C, DIN 2501/316L	<b>B 62</b>	Flange DN 80, PN 40 Form B1, EN 1092-1/Hastelloy	<b>C 33</b>
Flange DN 100, PN 16 Form C, DIN 2501/Hastelloy	<b>B 63</b>	Flange DN 80, PN 40 Form B1, EN 1092-1/ECTFE <sup>5)</sup>	<b>C 34</b>
Flange DN 100, PN 16 Form C, DIN 2501/ECTFE <sup>5)</sup>	<b>B 64</b>	Flange DN 80, PN 40 Form B1, EN 1092-1/Enamelled <sup>6)</sup>	<b>C 35</b>
Flange DN 100, PN 16 Form C, DIN 2501/PFA <sup>5)</sup>	<b>B 65</b>	Flange DN 80, PN 40 Form B2, EN 1092-1/316L	<b>C 36</b>
Flange DN 100, PN 16 Form C, DIN 2501/Enamelled <sup>6)</sup>	<b>B 66</b>	Flange DN 100, PN 16 Form B1, EN 1092-1/316L	<b>C 37</b>
Flange DN 100, PN 16 Form D, DIN 2501/316L	<b>B 67</b>	Flange DN 100, PN 16 Form B1, EN 1092-1/Hastelloy	<b>C 38</b>



# Level measurement

## Point level measurement – Vibrating switches

### SITRANS LVL200

#### Selection and Ordering data

Article No.

#### SITRANS LVL200, Standard

Compact vibrating level switch for use in liquid and slurry applications such as overflow, high, low, and demand applications, as well as pump protection. For use in SIL-2 and hazardous applications.

7ML5746-

- A 0

Flange DN 100, PN 16 Form B1, EN 1092-1/Enamelled <sup>6)</sup>	C 4 0
Flange DN 100, PN 40 Form B1, EN 1092-1/316L	C 4 1
Flange DN 100, PN 40 Form B1, EN 1092-1/Enamelled <sup>6)</sup>	C 4 2
Flange DN 100, PN 40 Form C, EN 1092-1/316L	C 4 3
Flange DN 100, PN 63 Form B2, EN 1092-1/316L	C 4 4
Flange DN 150, PN 16 Form B1, EN 1092-1/316L	C 4 5
Flange DN 150, PN 16 Form B1, EN 1092-1/PFA <sup>5)</sup>	C 4 6
Flange DN 150, PN 40 Form B1, EN 1092-1/316L	C 4 7
Flange DN 150, PN 40 Form B1, EN 1092-1/ECTFE <sup>5)</sup>	C 4 8
Flange DN 150, PN 40 Form B2, EN 1092-1/316L	C 5 0
Flange 1" 150 lb ANSI B16.5/316L	C 5 1
Flange 1" 150 lb RF, ANSI B16.5/Hastelloy	C 5 2
Flange 1" 150 lb RF, ANSI B16.5/Monel ZB2977	C 5 3
Flange 1" 150 lb RF, ANSI B16.5/ECTFE <sup>5)</sup>	C 5 4
Flange 1" 150 lb RF, ANSI B16.5/PFA <sup>5)</sup>	C 5 5
Flange 1" 150 lb RF, ANSI B16.5/Enamelled <sup>6)</sup>	C 5 6
Flange 1" 300 lb RF, ANSI B16.5/316L	C 5 7
Flange 1" 300 lb RF, ANSI B16.5/ECTFE <sup>5)</sup>	C 5 8
Flange 1" 600 lb RF, ANSI B16.5/316L	C 6 0
Flange 1½" 150 lb RF, ANSI B16.5/316L	C 6 1
Flange 1½" 150 lb RF, ANSI B16.5/Hastelloy	C 6 2
Flange 1½" 150 lb RF, ANSI B16.5/ECTFE <sup>5)</sup>	C 6 3
Flange 1½" 150 lb RF, ANSI B16.5/PFA <sup>5)</sup>	C 6 4
Flange 1½" 150 lb RF, ANSI B16.5 Enamelled <sup>6)</sup>	C 6 5
Flange 1½" 150 lb FF, ANSI B16.5/ECTFE <sup>5)</sup>	C 6 6
Flange 1½" 300 lb RF, ANSI B16.5/316L	C 6 7
Flange 1½" 300 lb RF, ANSI B16.5/Monel ZB2977	C 6 8
Flange 1½" 300 lb RF, ANSI B16.5/ECTFE <sup>6)</sup>	C 7 0
Flange 1½" 600 lb RF, ANSI B16.5/316L	C 7 1
Flange 2" 150 lb RF, ANSI B16.5/316L	C 7 2
Flange 2" 150 lb RF, ANSI B16.5/Hastelloy	C 7 3
Flange 2" 150 lb RF, ANSI B16.5/Monel ZB2977	C 7 4
Flange 2" 150 lb RF, ANSI B16.5/ECTFE <sup>5)</sup>	C 7 5
Flange 2" 150 lb RF, ANSI B16.5/PFA <sup>5)</sup>	C 7 6
Flange 2" 150 lb RF, ANSI B16.5/Enamelled <sup>6)</sup>	C 7 7
Flange 2" 150 lb FF, ANSI B16.5/316L	C 7 8
Flange 2" 150 lb FF, ANSI B16.5/ECTFE <sup>5)</sup>	C 8 0
Flange 2" 150 lb SG (small groove), ANSI B16.5/316L	C 8 1
Flange 2" 300 lb RF, ANSI B16.5/316L	C 8 2
Flange 2" 300 lb RF, ANSI B16.5/Hastelloy	C 8 3
Flange 2" 300 lb RF, ANSI B16.5/ECTFE <sup>5)</sup>	C 8 5
Flange 2" 300 lb RF, ANSI B16.5/PFA <sup>5)</sup>	C 8 6
Flange 2" 300 lb RF, ANSI B16.5 Enamelled <sup>6)</sup>	C 8 7
Flange 2" 300 lb RJF, ANSI B16.5/316L	C 8 8
Flange 2" 300 lb ST, ANSI B16.5/316L	D 0 0
Flange 2" 300 lb LG (large groove), ANSI B16.5/316L	D 0 1
Flange 2" 300 lb LT, ANSI B16.5/316L	D 0 2
Flange 2" 600 lb RF, ANSI B16.5/316L	D 0 3
Flange 2" 600 lb RF, ANSI B16.5/Monel ZB2977	D 0 4
Flange 2" 600 lb RF, ANSI B16.5/ECTFE <sup>5)</sup>	D 0 5
Flange 2" 600 lb RJF, ANSI B16.5/316L	D 0 6
Flange 2" 600 lb LG, ANSI B16.5/316L	D 0 7
Flange 2" 900 lb RJF, ANSI B16.5/316L	D 0 8
Flange 2½" 150 lb RF, ANSI B16.5/316L	D 1 0
Flange 2½" 300 lb RF, ANSI B16.5/316L	D 1 1

#### Selection and Ordering data

Article No.

#### SITRANS LVL200, Standard

Compact vibrating level switch for use in liquid and slurry applications such as overflow, high, low, and demand applications, as well as pump protection. For use in SIL-2 and hazardous applications.

7ML5746-

- A 0

Flange 3" 150 lb RF, ANSI B16.5/316L	D 1 2
Flange 3" 150 lb RF, ANSI B16.5/Hastelloy	D 1 3
Flange 3" 150 lb RF, ANSI B16.5/ECTFE <sup>5)</sup>	D 1 4
Flange 3" 150 lb RF, ANSI B16.5/PFA <sup>5)</sup>	D 1 5
Flange 3" 150 lb RF, ANSI B16.5/Enamelled <sup>6)</sup>	D 1 6
Flange 3" 150 lb FF, ANSI B16.5/316L	D 1 7
Flange 3" 150 lb FF, ANSI B16.5/ECTFE <sup>5)</sup>	D 1 8
Flange 3" 150 lb FF, ANSI B16.5/PFA <sup>5)</sup>	D 2 0
Flange 3" 300 lb RF, ANSI B16.5/316L	D 2 1
Flange 3" 300 lb RF, ANSI B16.5/Hastelloy	D 2 2
Flange 3" 300 lb RF, ANSI B16.5/ECTFE <sup>5)</sup>	D 2 3
Flange 3" 300 lb RF, ANSI B16.5/PFA <sup>5)</sup>	D 2 4
Flange 3" 300 lb RF, ANSI B16.5/Enamelled <sup>6)</sup>	D 2 5
Flange 3" 600 lb RF, ANSI B16.5/316L	D 2 6
Flange 3½" 150 lb RF, ANSI B16.5/316L	D 2 7
Flange 3½" 150 lb RF, ANSI B16.5/ECTFE <sup>5)</sup>	D 2 8
Flange 4" 150 lb RF, ANSI B16.5/316L	D 3 0
Flange 4" 150 lb RF, ANSI B16.5/Hastelloy	D 3 1
Flange 4" 150 lb RF, ANSI B16.5/ECTFE <sup>5)</sup>	D 3 2
Flange 4" 150 lb RF, ANSI B16.5/PFA <sup>5)</sup>	D 3 3
Flange 4" 150 lb RF, ANSI B16.5/Enamelled <sup>6)</sup>	D 3 4
Flange 4" 150 lb LT, ANSI B16.5/316L	D 3 5
Flange 4" 300 lb RF, ANSI B16.5/316L	D 3 6
Flange 4" 300 lb RF, ANSI B16.5/Hastelloy	D 3 7
Flange 4" 300 lb RF, ANSI B16.5/ECTFE <sup>5)</sup>	D 3 8
Flange 4" 300 lb RJF, ANSI B16.5/316L	D 4 0
Flange 4" 300 lb LG, ANSI B16.5/316L	D 4 1
Flange 4" 300 lb LT, ANSI B16.5/316L	D 4 2
Flange 4" 600 lb RF, ANSI B16.5/316L	D 4 3
Flange 4" 600 lb RJF, ANSI B16.5/316L	D 4 4
Flange 6" 150 lb RF, ANSI B16.5/316L	D 4 5
Flange 6" 150 lb RF, ANSI B16.5/Hastelloy	D 4 6
Flange 6" 150 lb RF, ANSI B16.5/ECTFE <sup>5)</sup>	D 4 7
Flange 6" 150 lb RF, ANSI B16.5/PFA <sup>5)</sup>	D 4 8
Flange 6" 150 lb RJF, ANSI B16.5/316L	D 5 0
Flange 6" 300 lb RF, ANSI B16.5/316L	D 5 1
Flange 8" 150 lb RF, ANSI B16.5/316L	D 5 2
Flange 8" 150 lb RF, ANSI B16.5/ECTFE <sup>5)</sup>	D 5 3
Flange 1" BS.10 Table E/316L	D 5 4
Flange 1" BS.10 Table E/PFA <sup>5)</sup>	D 5 5
Flange 1½" BS.10 Table E/316L	D 5 6
Flange 3½" BS.10 Table E/316L	D 5 7
Flange 4" BS.10 Table E/ECTFE <sup>5)</sup>	D 5 8
Flange DN 40 10K, JIS/316L	D 6 0
Flange DN 50 10K, JIS/316L	D 6 1
Flange DN 80 10K, JIS/316L	D 6 2
Flange DN 100 10K, JIS/316L	D 6 3
<b>Adapter/Process temperature</b>	
Without adapter/-50 ... +150 °C (-58 ... +302 °F)	1
With adapter/-50 ... +200 °C (-58 ... +392 °F) <sup>7)</sup>	2
With adapter/-50 ... +250 °C (-58 ... +482 °F)	3
With gas-tight leadthrough/-50 ... +150 °C (-58 ... +302 °F)	4
With gas-tight leadthrough/-50 ... +250 °C (-58 ... +482 °F)	5



# Level measurement

## Point level measurement – Vibrating switches

### SITRANS LVL200

#### Selection and Ordering data

Article No.

#### SITRANS LVL200, Rigid extension

Compact vibrating level switch for use in liquid applications such as overflow, high, low, and demand applications, as well as pump protection. For use in SIL-2 and hazardous applications.

7ML5747-

#### Electronics

Contactless electronic switch 20...250 V AC/DC  
Double relay (DPDT) 20 ... 72 V DC/20 ... 250 V AC  
NAMUR signal<sup>1)</sup>

1  
2  
4

#### Approvals

Without approvals  
Overfill protection (WHG)  
ATEX II 1G, 1/2G, 2G EEx ia IIC T6 + WHG<sup>2)</sup>  
ATEX II 1/2G, 2G EEx d IIC T6 + WHG<sup>3)4)</sup>  
ATEX II 1G, 1/2G, 2G EEx ia IIC T6 + shipping approvals<sup>2)</sup>  
ATEX II 1/2G, 2G EEx d IIC T6 + shipping approvals<sup>3)4)</sup>  
ATEX II 1G, 1/2G, 2G EEx ia IIC T6 + ATEX II 1/2D IP6X T<sup>2)</sup>  
IECEX Ex ia IIC T6<sup>2)</sup>  
Shipping approvals  
FM (IS) Class I, II, III, Div. 1, Groups A, B, C, D, E, F, G<sup>2)5)</sup>  
FM (XP) Class I, Div. 1, Groups A, B, C, D; (DIP) Class II, III, Div. 1, Groups E, F, G<sup>3)4)5)</sup>  
FM (NI) Class I, Div. 2, Groups A, B, C, D<sup>5)</sup>  
IECEX d IIC T6...T2 Ga/Gb<sup>4)</sup>  
CSA(XP)CL I,II,III Div. 1, Groups A, B, C, D, E, F, G...T2<sup>4)</sup>  
Ga/Gb  
CSA(NI)CL I,II,III, Div. 2, Groups A, B, C, D, E, F, G  
BR-Ex d IIC T6...T2  
CSA(IS)CL I, II, III Div. 1, Groups A, B, C, D, E, F, G

A  
B  
C  
D  
E  
F  
G  
H  
K  
N  
P  
Q  
R  
S  
T  
U  
V

#### Process connection

Thread G<sup>3</sup>/<sub>4</sub>" A, PN 64/316L  
Thread G<sup>3</sup>/<sub>4</sub>" A, PN 64/316L Ra < 0.8 µm  
Thread <sup>3</sup>/<sub>4</sub>" NPT, PN 64/316L  
Thread <sup>3</sup>/<sub>4</sub>" NPT, PN 64/316L Ra < 0.8 µm  
Thread <sup>3</sup>/<sub>4</sub>" NPT, PN 64/Monel  
Thread G<sup>3</sup>/<sub>4</sub>" A, PN 64/Hastelloy  
Thread <sup>3</sup>/<sub>4</sub>" NPT, PN 64/Hastelloy  
Thread G1" A, PN 64/316L  
Thread G1" A, PN 64/316L ECTFE coated MB1982<sup>6)</sup>  
Thread G1" A, PN 64/316L PFA coated<sup>6)</sup>  
Thread G1" A, PN 64/Monel  
Thread G1" A, PN 64/316L Ra < 0.8 µm  
Thread 1" NPT, PN 64/316L  
Thread 1" NPT, PN 64/316L ECTFE coated MB1982<sup>6)</sup>  
Thread 1" NPT, PN 64/316L PFA coated<sup>6)</sup>  
Thread 1" NPT, PN 64/Monel  
Thread 1" NPT, PN 64/316L Ra < 0.8 µm  
Thread G1" A, PN 64/Hastelloy  
Thread G1<sup>1</sup>/<sub>2</sub>" A, PN 64/316L  
Thread G1<sup>1</sup>/<sub>2</sub>" A, PN 64/316L Ra < 0.8 µm  
Thread G1<sup>1</sup>/<sub>2</sub>" A, PN 64/Hastelloy  
Thread 1" NPT, PN 64/Hastelloy  
Thread 1<sup>1</sup>/<sub>2</sub>" NPT, PN 64/316L  
Thread 1<sup>1</sup>/<sub>2</sub>" NPT, PN 64/316L Ra < 0.8 µm  
Thread 1<sup>1</sup>/<sub>2</sub>" NPT, PN 64/Hastelloy  
Thread G2" A, PN 64/316L  
Thread M27x1.5 PN 64/316L  
Cyl. socket/316Ti/1.4581 ECTFE coated ZB2984<sup>6)</sup>  
Conus DN 25 PN 40/316L Ra < 0.3 µm  
Conus DN 25 PN 40/316L Ra < 0.8 µm

A 0 0  
A 0 1  
A 0 2  
A 0 3  
A 0 4  
A 0 5  
A 0 6  
A 0 7  
A 0 8  
A 1 0  
A 1 1  
A 1 3  
A 1 4  
A 1 5  
A 1 6  
A 1 7  
A 1 8  
A 2 0  
A 2 1  
A 2 2  
A 2 3  
A 2 4  
A 2 5  
A 2 6  
A 2 7  
A 2 8  
A 3 0  
A 3 1  
A 3 2  
A 3 3

#### Selection and Ordering data

Article No.

#### SITRANS LVL200, Rigid extension

Compact vibrating level switch for use in liquid applications such as overflow, high, low, and demand applications, as well as pump protection. For use in SIL-2 and hazardous applications.

7ML5747-

Conus DN 25 PN 40/ECTFE (ZB3033)<sup>6)</sup>

A 3 4

Conus M52 PN 40/316L

A 3 5

Conus M52 PN 40/316L Ra &lt; 0.3 µm

A 3 6

Conus M52 PN 40/316L Ra &lt; 0.8 µm

A 3 7

Tri-Clamp 1" PN 16/316L Ra &lt; 0.3 µm

A 3 8

Tri-Clamp 1" PN 16/Hastelloy

A 4 0

Tri-Clamp 1" PN 16/316L Ra &lt; 0.8 µm

A 4 1

Tri-Clamp 1<sup>1</sup>/<sub>2</sub>" PN 16/316L Ra < 0.3 µm

A 4 2

Tri-Clamp 1<sup>1</sup>/<sub>2</sub>" PN 16/Hastelloy

A 4 3

Tri-Clamp 1<sup>1</sup>/<sub>2</sub>" PN 16/316L Ra < 0.8 µm

A 4 4

Tri-Clamp 2" PN 16/316L Ra &lt; 0.3 µm

A 4 5

Tri-Clamp 2" PN 16/Hastelloy

A 4 6

Tri-Clamp 2" PN 16/316L Ra &lt; 0.8 µm

A 4 7

Tri-Clamp 2<sup>1</sup>/<sub>2</sub>" PN 10/316L Ra < 0.3 µm

A 4 8

Tri-Clamp 2<sup>1</sup>/<sub>2</sub>" PN 10/316L Ra < 0.8 µm

A 5 0

Tri-Clamp 3" PN 10/316L Ra &lt; 0.3 µm

A 5 1

Tri-Clamp 3" PN 10/316L Ra &lt; 0.8 µm

A 5 2

Bolting DN 32 PN 40 DIN11851/316L Ra &lt; 0.3 µm

A 5 3

Bolting DN 32 PN 40 DIN11851/316L Ra &lt; 0.8 µm

A 5 4

Bolting DN 25 PN 40 DIN11851/316L Ra &lt; 0.3 µm

A 5 5

Bolting DN 25 PN 40 DIN11851/316L Ra &lt; 0.8 µm

A 5 6

Bolting DN 40 PN 40 DIN11851/316L Ra &lt; 0.3 µm

A 5 7

Bolting DN 40 PN 40 DIN11851/316L Ra &lt; 0.8 µm

A 5 8

Bolting DN 40 PN 40 DIN11864-1 A/316L Ra &lt; 0.8 µm ZB3052

A 6 0

Bolting DN 50 PN 25 DIN11851/316L Ra &lt; 0.3 µm

A 6 1

Bolting DN 50 PN 25 DIN11851/316L Ra &lt; 0.8 µm

A 6 2

Bolting DN 50 PN 25 DIN11864-1 A/316L Ra &lt; 0.8 µm ZB3052

A 6 3

Hygienic w.compr.nut F40 PN 25/316L

A 6 4

Hygienic w.compr.nut F40 PN 25/316L Ra &lt; 0.3 µm

A 6 5

Hygienic w.compr.nut F40 PN 25/316L Ra &lt; 0.8 µm

A 6 6

Varivent N50-40/316L Ra &lt; 0.3 µm

A 6 7

Varivent N50-40/316L Ra &lt; 0.8 µm

A 6 8

Varivent N125/100/316L Ra &lt; 0.8 µm

A 7 0

DRD flange PN 40/316L ZB3007

A 7 1

SMS DN 38/316L Ra < 0.8 µm<sup>6)</sup>

A 7 2

SMS DN 51 PN 6/316L Ra < 0.8 µm<sup>6)</sup>

A 7 3

Swagelok VCR screwing ZG2579 PN 64/316L

A 7 4

Neumo biocontrol size 25 PN 16/316L Ra &lt; 0.8 µm

A 7 5

Neumo biocontrol size 50 PN 16/316L Ra &lt; 0.8 µm

A 7 6

Neumo biocontrol size 65 PN 16/316L Ra &lt; 0.8 µm

A 7 7

Neumo biocontrol size 80 PN 16/316L Ra &lt; 0.8 µm

A 7 8

SÜDMO DN 50 PN 10/316L Ra &lt; 0.8 µm

A 8 0

Small flange DN 25 PN 1.5 DIN 28403/316L pol. Ra &lt; 0.8 µm

A 8 1

Small flange DN 40 PN 1.5 DIN 28403/316L pol. Ra &lt; 0.8 µm

A 8 2

Ingold connection PN 16/316L Ra &lt; 0.8 µm

A 8 3

Terminal DN 33.7 PN 40 DIN 11864-3-A-/316L BN2 Ra &lt; 0.8 µm

A 8 4

Hygienic fl. DN 50 PN 16 DIN 11864-2-A-/316L Ra &lt; 0.8 µm

A 8 5

Flange DN 25 PN 6 Form C, DIN 2501/316L

A 8 6

Flange DN 25 PN 6 Form C, DIN 2501/PFA<sup>6)</sup>

A 8 7

Flange DN 25 PN 40 Form C, DIN 2501/316L

A 8 8

Flange DN 25 PN 40 Form C, DIN 2501/Hastelloy

B 0 0

Flange DN 25 PN 40 Form C, DIN 2501/ECTFE<sup>6)</sup>

B 0 1

Flange DN 25 PN 40 Form C, DIN 2501/PFA<sup>6)</sup>

B 0 2

Flange DN 25 PN 40 Form D, DIN 2501/316L

B 0 3

# Level measurement

## Point level measurement – Vibrating switches

SITRANS LVL200

Selection and Ordering data	Article No.	Selection and Ordering data	Article No.
<b>SITRANS LVL200, Rigid extension</b> Compact vibrating level switch for use in liquid applications such as overflow, high, low, and demand applications, as well as pump protection. For use in SIL-2 and hazardous applications.	<b>7ML5747-</b>	<b>SITRANS LVL200, Rigid extension</b> Compact vibrating level switch for use in liquid applications such as overflow, high, low, and demand applications, as well as pump protection. For use in SIL-2 and hazardous applications.	<b>7ML5747-</b>
Flange DN 25 PN 40 Form F, DIN 2501/316L	<b>B 04</b>	Flange DN 100 PN 40 Form C, DIN 2501/316L	<b>B 67</b>
Flange DN 25 PN 40 Form N, DIN 2501/316L	<b>B 05</b>	Flange DN 100 PN 40 Form C, DIN 2501/ECTFE <sup>6)</sup>	<b>B 68</b>
Flange DN 25 PN 40 Form N, DIN 2501/Hastelloy	<b>B 06</b>	Flange DN 100 PN 40 Form C, DIN 2501/PFA <sup>6)</sup>	<b>B 70</b>
Flange DN 25 PN 40 Form N, DIN 2501/Monel solid	<b>B 07</b>	Flange DN 100 PN 40 Form C, DIN 2501/ Enamelled <sup>7)</sup>	<b>B 71</b>
Flange DN 25 PN 40 V13, DIN 2501/316L	<b>B 08</b>	Flange DN 100 PN 40 Form F, DIN 2501/316L	<b>B 72</b>
Flange DN 32 PN 40 Form C, DIN 2501/316L	<b>B 10</b>	Flange DN 100 PN 40 Form N, DIN 2501/316L	<b>B 73</b>
Flange DN 32 PN 40 Form C, DIN 2501/ECTFE <sup>6)</sup>	<b>B 11</b>	Flange DN 100 PN 40 V13, DIN 2501/316L	<b>B 74</b>
Flange DN 40 PN 6 Form C, DIN 2501/316L	<b>B 12</b>	Flange DN 100 PN 64 Form E, DIN 2501/316L	<b>B 75</b>
Flange DN 40 PN 6 Form C, DIN 2501/ECTFE <sup>6)</sup>	<b>B 13</b>	Flange DN 100 PN 100 Form E, DIN 2501/316L	<b>B 76</b>
Flange DN 40 PN 40 Form C, DIN 2501/316L	<b>B 14</b>	Flange DN 100 PN 100 Form L, DIN 2501/316L	<b>B 77</b>
Flange DN 40 PN 40 Form C, DIN 2501/Hastelloy	<b>B 15</b>	Flange DN 125 PN 16 Form F, DIN 2501/316L	<b>B 78</b>
Flange DN 40 PN 40 Form C, DIN 2501/ECTFE <sup>6)</sup>	<b>B 16</b>	Flange DN 125 PN 40 Form C, DIN 2501/316L	<b>B 80</b>
Flange DN 40 PN 40 Form C, DIN 2501/PFA <sup>6)</sup>	<b>B 17</b>	Flange DN 125 PN 40 Form N, DIN 2512/316L	<b>B 81</b>
Flange DN 40 PN 40 Form C, DIN 2501/Enamelled <sup>7)</sup>	<b>B 18</b>	Flange DN 150 PN 16 Form C, DIN 2501/316L	<b>B 82</b>
Flange DN 40 PN 40 Form F, DIN 2501/316L	<b>B 20</b>	Flange DN 150 PN 16 Form C, DIN 2501/Hastelloy	<b>B 83</b>
Flange DN 40 PN 40 Form N, DIN 2501/316L	<b>B 21</b>	Flange DN 150 PN 16 Form C, DIN 2501/ECTFE <sup>6)</sup>	<b>B 84</b>
Flange DN 40 PN 40 Form E, DIN 2501/316L	<b>B 22</b>	Flange DN 150 PN 16 Form C, DIN 2501/PFA <sup>6)</sup>	<b>B 85</b>
Flange DN 40 PN 40 V13, DIN 2501/316L	<b>B 23</b>	Flange DN 150 PN 16 Form D, DIN 2501/316L	<b>B 86</b>
Flange DN 50 PN 40 Form C, DIN 2501/316L	<b>B 24</b>	Flange DN 150 PN 40 Form C, DIN 2501/316L	<b>B 87</b>
Flange DN 50 PN 40 Form C, DIN 2501/Hastelloy	<b>B 25</b>	Flange DN 150 PN 40 Form C, DIN 2501/Hastelloy	<b>B 88</b>
Flange DN 50 PN 40 Form C, DIN 2501/ECTFE <sup>6)</sup>	<b>B 26</b>	Flange DN 150 PN 40 Form F, DIN 2501/316L	<b>C 00</b>
Flange DN 50 PN 40 Form C, DIN 2501/ECTFE (ZB3108) <sup>6)</sup>	<b>B 27</b>	Flange DN 150 PN 40 Form N, DIN 2512/316L	<b>C 01</b>
Flange DN 50 PN 40 Form C, DIN 2501/PFA <sup>6)</sup>	<b>B 28</b>	Flange DN 200 PN 10 Form C, DIN 2501/ECTFE <sup>6)</sup>	<b>C 02</b>
Flange DN 50 PN 40 Form D, DIN 2501/316L	<b>B 30</b>	Flange DN 200 PN 16 Form C, DIN 2501/316L	<b>C 03</b>
Flange DN 50 PN 40 Form D, DIN 2501/Hastelloy	<b>B 31</b>	Flange DN 25 PN 40 Form B1, EN 1092-1/316L	<b>C 04</b>
Flange DN 50 PN 40 Form F, DIN 2501/316L	<b>B 32</b>	Flange DN 25 PN 40 Form B1, EN 1092-1/Hastelloy	<b>C 05</b>
Flange DN 50 PN 40 Form N, DIN 2501/316L	<b>B 33</b>	Flange DN 25 PN 40 Form B1, EN/316L/PFA <sup>6)</sup>	<b>C 06</b>
Flange DN 50 PN 40 Form N, DIN 2501/Hastelloy	<b>B 34</b>	Flange DN 25 PN 40 Form B1, EN 1092-1/ Enamelled <sup>7)</sup>	<b>C 07</b>
Flange DN 50 PN 40 Form N, DIN 2501/316L	<b>B 35</b>	Flange DN 25 PN 40 Form B2, EN 1092-1/316L	<b>C 08</b>
Flange DN 50 PN 40 Form E, DIN 2501/316L	<b>B 35</b>	Flange DN 25 PN 40 Form F, EN 1092-1/316L	<b>C 10</b>
Flange DN 50 PN 40 V13, DIN 2501/316L	<b>B 36</b>	Flange DN 25 PN 63 Form B1, EN 1092-1/316L	<b>C 11</b>
Flange DN 50 PN 40 R13, DIN 2501/316L	<b>B 37</b>	Flange DN 25 PN 100 Form B2, EN 1092-1/316L	<b>C 12</b>
Flange DN 50 PN 64 Form F, DIN 2501/316L	<b>B 38</b>	Flange DN 40 PN 40 Form B1, EN/316L	<b>C 13</b>
Flange DN 50 PN 64 Form N, DIN 2501/Hastelloy	<b>B 40</b>	Flange DN 40 PN 40 Form B1, EN 1092-1/PFA <sup>6)</sup>	<b>C 14</b>
Flange DN 50 PN 64 Form C, DIN 2501/316L	<b>B 41</b>	Flange DN 40 PN 40 Form B2, EN/316L	<b>C 15</b>
Flange DN 50 PN 64 Form L, DIN 2501/316L	<b>B 42</b>	Flange DN 50 PN 40 Form B1, EN/316L	<b>C 16</b>
Flange DN 50 PN 100 Form E, DIN 2501/316L	<b>B 43</b>	Flange DN 50 PN 40 Form B1, EN 1092-1/Hastelloy	<b>C 17</b>
Flange DN 50 PN 100 Form L, DIN 2501/316L	<b>B 44</b>	Flange DN 50 PN 40 Form B1, EN 1092-1/ Monel ZB2977	<b>C 18</b>
Flange DN 65 PN 40 Form C, DIN 2501/316L	<b>B 45</b>	Flange DN 50 PN 40 Form B1, EN 1092-1/ECTFE <sup>6)</sup>	<b>C 20</b>
Flange DN 65 PN 40 Form C, DIN 2501/Hastelloy	<b>B 46</b>	Flange DN 50 PN 40 Form B1, EN/316L/PFA <sup>6)</sup>	<b>C 21</b>
Flange DN 65 PN 40 Form C, DIN 2501/ECTFE <sup>6)</sup>	<b>B 47</b>	Flange DN 50 PN 40 Form B1, EN 1092-1/ Enamelled <sup>7)</sup>	<b>C 22</b>
Flange DN 65 PN 40 Form C, DIN 2501/PFA <sup>6)</sup>	<b>B 48</b>	Flange DN 50 PN 40 Form C, EN 1092-1/316L	<b>C 23</b>
Flange DN 65 PN 40 Form F, DIN 2501/316L	<b>B 50</b>	Flange DN 50 PN 40 Form D, EN/316L	<b>C 24</b>
Flange DN 65 PN 64 Form E, DIN 2501/316L	<b>B 51</b>	Flange DN 50 PN 40 Form D, EN 1092-1/ Hastelloy	<b>C 25</b>
Flange DN 80 PN 40 Form C, DIN 2501/316L	<b>B 52</b>	Flange DN 50 PN 40 Form B2, EN 1092-1/316L	<b>C 26</b>
Flange DN 80 PN 40 Form C, DIN 2501/Hastelloy	<b>B 53</b>	Flange DN 50 PN 40 Form E, EN 1092-1/316L	<b>C 27</b>
Flange DN 80 PN 40 Form C, DIN 2501/ECTFE <sup>6)</sup>	<b>B 54</b>	Flange DN 80 PN 40 Form B1, EN 1092-1/316L	<b>C 28</b>
Flange DN 80 PN 40 Form C, DIN 2501/PFA <sup>6)</sup>	<b>B 55</b>	Flange DN 80 PN 40 Form B1, EN 1092-1/Hastelloy	<b>C 30</b>
Flange DN 80 PN 40 Form F, DIN 2501/316L	<b>B 56</b>	Flange DN 80 PN 40 Form B1, EN 1092-1/ECTFE <sup>6)</sup>	<b>C 31</b>
Flange DN 80 PN 40 Form N, DIN 2501/316L	<b>B 57</b>	Flange DN 80 PN 40 Form B1, EN 1092-1/ Enamelled <sup>7)</sup>	<b>C 32</b>
Flange DN 80 PN 40 Form N, DIN 2501/Hastelloy	<b>B 58</b>	Flange DN 80 PN 40 Form B2, EN 1092-1/316L	<b>C 33</b>
Flange DN 100 PN 16 Form C, DIN 2501/316L	<b>B 60</b>	Flange DN 100 PN 16 Form B1, EN 1092-1/316L	<b>C 34</b>
Flange DN 100 PN 16 Form C, DIN 2501/Hastelloy	<b>B 61</b>	Flange DN 100 PN 16 Form B1, EN 1092-1/ Hastelloy	<b>C 35</b>
Flange DN 100 PN 16 Form C, DIN 2501/ECTFE <sup>6)</sup>	<b>B 62</b>	Flange DN 100 PN 16 Form B1, EN 1092-1/ Enamelled <sup>7)</sup>	<b>C 36</b>
Flange DN 100 PN 16 Form C, DIN 2501/PFA <sup>6)</sup>	<b>B 63</b>		
Flange DN 100 PN 16 Form D, DIN 2501/316L	<b>B 64</b>		
Flange DN 100 PN 16 Form F, DIN 2501/316L	<b>B 65</b>		
Flange DN 100 PN 16 Form N, DIN 2501/316L	<b>B 66</b>		



# Level measurement

## Point level measurement – Vibrating switches

### SITRANS LVL200

#### Selection and Ordering data

Article No.

#### SITRANS LVL200, Rigid extension

Compact vibrating level switch for use in liquid applications such as overflow, high, low, and demand applications, as well as pump protection. For use in SIL-2 and hazardous applications.

7ML5747-

Flange DN 100 PN 40 Form B1, EN 1092-1/316L	<b>C 37</b>
Flange DN 100 PN 40 Form B1, EN 1092-1/Enamelled <sup>7)</sup>	<b>C 38</b>
Flange DN 100 PN 40 Form C, EN 1092-1/316L	<b>C 40</b>
Flange DN 100 PN 63 Form B2, EN 1092-1/316L	<b>C 41</b>
Flange DN 150 PN 16 Form B1, EN 1092-1/316L	<b>C 42</b>
Flange DN 150 PN 16 Form B1, EN 1092-1/PFA <sup>6)</sup>	<b>C 43</b>
Flange DN 150 PN 40 Form B1, EN 1092-1/316L	<b>C 44</b>
Flange DN 150 PN 40 Form B1, EN 1092-1/ECTFE <sup>6)</sup>	<b>C 45</b>
Flange DN 150 PN 40 Form B2, EN 1092-1/316L	<b>C 46</b>
Flange 1" 150 lb ANSI B16.5/316L	<b>C 47</b>
Flange 1" 150 lb RF, ANSI B16.5/Hastelloy	<b>C 48</b>
Flange 1" 150 lb RF, ANSI B16.5/Monel ZB2977	<b>C 50</b>
Flange 1" 150 lb RF, ANSI B16.5/ECTFE <sup>6)</sup>	<b>C 51</b>
Flange 1" 150 lb RF, ANSI B16.5/PFA <sup>6)</sup>	<b>C 52</b>
Flange 1" 150 lb RF, ANSI B16.5/Enamelled <sup>7)</sup>	<b>C 53</b>
Flange 1" 300 lb RF, ANSI B16.5/316L	<b>C 54</b>
Flange 1" 300 lb RF, ANSI B16.5/ECTFE <sup>6)</sup>	<b>C 55</b>
Flange 1" 600 lb RF, ANSI B16.5/316L	<b>C 56</b>
Flange 1½" 150 lb RF, ANSI B16.5/316L	<b>C 57</b>
Flange 1½" 150 lb RF, ANSI B16.5/Hastelloy	<b>C 58</b>
Flange 1½" 150 lb RF, ANSI B16.5/ECTFE <sup>6)</sup>	<b>C 60</b>
Flange 1½" 150 lb RF, ANSI B16.5/PFA <sup>6)</sup>	<b>C 61</b>
Flange 1½" 150 lb RF, ANSI B16.5 Enamelled <sup>7)</sup>	<b>C 62</b>
Flange 1½" 150 lb FF, ANSI B16.5/ECTFE <sup>6)</sup>	<b>C 63</b>
Flange 1½" 300 lb RF, ANSI B16.5/316L	<b>C 64</b>
Flange 1½" 300 lb RF, ANSI B16.5/Monel ZB2977	<b>C 65</b>
Flange 1½" 300 lb RF, ANSI B16.5/ECTFE <sup>6)</sup>	<b>C 66</b>
Flange 1½" 600 lb RF, ANSI B16.5/316L	<b>C 67</b>
Flange 2" 150 lb RF, ANSI B16.5/316L	<b>C 68</b>
Flange 2" 150 lb RF, ANSI B16.5/Hastelloy	<b>C 70</b>
Flange 2" 150 lb RF, ANSI B16.5/Monel ZB2977	<b>C 71</b>
Flange 2" 150 lb RF, ANSI B16.5/ECTFE <sup>6)</sup>	<b>C 72</b>
Flange 2" 150 lb RF, ANSI B16.5/PFA <sup>6)</sup>	<b>C 73</b>
Flange 2" 150 lb RF, ANSI B16.5/Enamelled <sup>7)</sup>	<b>C 74</b>
Flange 2" 150 lb FF, ANSI B16.5/316L	<b>C 75</b>
Flange 2" 150 lb FF, ANSI B16.5/ECTFE <sup>6)</sup>	<b>C 76</b>
Flange 2" 150 lb SG (small groove), ANSI B16.5/316L	<b>C 77</b>
Flange 2" 300 lb RF, ANSI B16.5/316L	<b>C 78</b>
Flange 2" 300 lb RF, ANSI B16.5/Hastelloy	<b>C 80</b>
Flange 2" 300 lb RF, ANSI B16.5/ECTFE <sup>6)</sup>	<b>C 82</b>
Flange 2" 300 lb RF, ANSI B16.5/PFA <sup>6)</sup>	<b>C 83</b>
Flange 2" 300 lb RF, ANSI B16.5 Enamelled <sup>7)</sup>	<b>C 84</b>
Flange 2" 300 lb RJF, ANSI B16.5/316L	<b>C 85</b>
Flange 2" 300 lb ST, ANSI B16.5/316L	<b>C 86</b>
Flange 2" 300 lb LG (large groove), ANSI B16.5/316L	<b>C 87</b>
Flange 2" 300 lb LT, ANSI B16.5/316L	<b>C 88</b>
Flange 2" 600 lb RF, ANSI B16.5/316L	<b>D 00</b>
Flange 2" 600 lb RF, ANSI B16.5/Monel ZB2977	<b>D 01</b>
Flange 2" 600 lb RF, ANSI B16.5/ECTFE <sup>6)</sup>	<b>D 02</b>
Flange 2" 600 lb RJF, ANSI B16.5/316L	<b>D 03</b>
Flange 2" 600 lb LG, ANSI B16.5/316L	<b>D 04</b>
Flange 2" 900 lb RJF, ANSI B16.5/316L	<b>D 05</b>
Flange 2½" 150 lb RF, ANSI B16.5/316L	<b>D 06</b>
Flange 2½" 300 lb RF, ANSI B16.5/316L	<b>D 07</b>
Flange 3" 150 lb RF, ANSI B16.5/316L	<b>D 08</b>

#### Selection and Ordering data

Article No.

#### SITRANS LVL200, Rigid extension

Compact vibrating level switch for use in liquid applications such as overflow, high, low, and demand applications, as well as pump protection. For use in SIL-2 and hazardous applications.

7ML5747-

Flange 3" 150 lb RF, ANSI B16.5/Hastelloy	<b>D 10</b>
Flange 3" 150 lb RF, ANSI B16.5/Monel ZB2977	<b>D 11</b>
Flange 3" 150 lb RF, ANSI B16.5/ECTFE <sup>6)</sup>	<b>D 12</b>
Flange 3" 150 lb RF, ANSI B16.5/PFA <sup>6)</sup>	<b>D 13</b>
Flange 3" 150 lb RF, ANSI B16.5/Enamelled <sup>7)</sup>	<b>D 14</b>
Flange 3" 150 lb FF, ANSI B16.5/316L	<b>D 15</b>
Flange 3" 150 lb FF, ANSI B16.5/ECTFE <sup>6)</sup>	<b>D 16</b>
Flange 3" 150 lb FF, ANSI B16.5/PFA <sup>6)</sup>	<b>D 17</b>
Flange 3" 300 lb RF, ANSI B16.5/316L	<b>D 18</b>
Flange 3" 300 lb RF, ANSI B16.5/Hastelloy	<b>D 20</b>
Flange 3" 300 lb RF, ANSI B16.5/ECTFE <sup>6)</sup>	<b>D 21</b>
Flange 3" 300 lb RF, ANSI B16.5/PFA <sup>6)</sup>	<b>D 22</b>
Flange 3" 300 lb RF, ANSI B16.5/Enamelled <sup>7)</sup>	<b>D 23</b>
Flange 3" 600 lb RF, ANSI B16.5/316L	<b>D 24</b>
Flange 3½" 150 lb RF, ANSI B16.5/316L	<b>D 25</b>
Flange 3½" 150 lb RF, ANSI B16.5/ECTFE <sup>6)</sup>	<b>D 26</b>
Flange 4" 150 lb RF, ANSI B16.5/316L	<b>D 27</b>
Flange 4" 150 lb RF, ANSI B16.5/Hastelloy	<b>D 28</b>
Flange 4" 150 lb RF, ANSI B16.5/ECTFE <sup>6)</sup>	<b>D 30</b>
Flange 4" 150 lb RF, ANSI B16.5/PFA <sup>6)</sup>	<b>D 31</b>
Flange 4" 150 lb RF, ANSI B16.5/Enamelled <sup>7)</sup>	<b>D 32</b>
Flange 4" 150 lb LT, ANSI B16.5/316L	<b>D 33</b>
Flange 4" 300 lb RF, ANSI B16.5/316L	<b>D 34</b>
Flange 4" 300 lb RF, ANSI B16.5/Hastelloy	<b>D 35</b>
Flange 4" 300 lb RF, ANSI B16.5/ECTFE <sup>6)</sup>	<b>D 36</b>
Flange 4" 300 lb RJF, ANSI B16.5/316L	<b>D 37</b>
Flange 4" 300 lb LG, ANSI B16.5/316L	<b>D 38</b>
Flange 4" 300 lb LT, ANSI B16.5/316L	<b>D 40</b>
Flange 4" 600 lb RF, ANSI B16.5/316L	<b>D 41</b>
Flange 4" 600 lb RJF, ANSI B16.5/316L	<b>D 42</b>
Flange 5" 150 lb RF, ANSI B16.5/316L	<b>D 43</b>
Flange 6" 150 lb RF, ANSI B16.5/316L	<b>D 44</b>
Flange 6" 150 lb RF, ANSI B16.5/Hastelloy	<b>D 45</b>
Flange 6" 150 lb RF, ANSI B16.5/ECTFE <sup>6)</sup>	<b>D 46</b>
Flange 6" 150 lb RF, ANSI B16.5/PFA <sup>6)</sup>	<b>D 47</b>
Flange 6" 150 lb RJF, ANSI B16.5/316L	<b>D 48</b>
Flange 6" 300 lb RF, ANSI B16.5/316L	<b>D 50</b>
Flange 8" 150 lb RF, ANSI B16.5/316L	<b>D 51</b>
Flange 8" 150 lb RF, ANSI B16.5/ECTFE <sup>6)</sup>	<b>D 52</b>
Flange 1" BS.10 Table E/316L	<b>D 53</b>
Flange 1" BS.10 Table E/PFA <sup>6)</sup>	<b>D 54</b>
Flange 1½" BS.10 Table E/316L	<b>D 55</b>
Flange 3½" BS.10 Table E/316L	<b>D 56</b>
Flange 4" BS.10 Table E/ECTFE <sup>6)</sup>	<b>D 57</b>
Flange DN 40 10K, JIS/316L	<b>D 58</b>
Flange DN 50 10K, JIS/316L	<b>D 60</b>
Flange DN 80 10K, JIS/316L	<b>D 61</b>
Flange DN 100 10K, JIS/316L	<b>D 62</b>

# Level measurement

## Point level measurement – Vibrating switches

SITRANS LVL200

Selection and Ordering data	Article No.	Selection and Ordering data	Article No.
<b>SITRANS LVL200, Rigid extension</b> Compact vibrating level switch for use in liquid applications such as overflow, high, low, and demand applications, as well as pump protection. For use in SIL-2 and hazardous applications.	7ML5747-	<b>SITRANS LVL200, Rigid extension</b> Compact vibrating level switch for use in liquid applications such as overflow, high, low, and demand applications, as well as pump protection. For use in SIL-2 and hazardous applications.	7ML5747-
<b>Adapter/Process temperature</b> Without adapter/-50 ... +150 °C With adapter/-50 ... +200 °C <sup>8)</sup> With adapter/-50... +250 °C With gas-tight leadthrough/-50 ... +150 °C With gas-tight leadthrough/-50 ... +250 °C	1 2 3 4 5	<b>Rigid Extension Enamelled version<sup>7)</sup></b> 80 ... 250 mm 251 ... 500 mm 501 ... 750 mm 751 ... 1 000 mm 1 001 ... 1 250 mm 1 251 ... 1 500 mm	F 0 F 1 F 2 F 3 F 4 F 5
<b>Housing/ Cable entry</b> Aluminium IP66/IP67/M20x1.5 Aluminium IP66/IP67/½" NPT 316L stainless steel (electropolished) IP66/IP67/M20X1.5 <sup>9)</sup> <sup>10)</sup> 316L stainless steel (electropolished) IP66/IP67/½" NPT <sup>9)</sup> <sup>10)</sup>	A B C D	<b>Rigid Extension Hastelloy</b> 80 ... 500 mm 501 ... 1 000 mm 1 001 ... 1 500 mm 1 501 ... 2 000 mm 2 001 ... 2 500 mm 2 501 ... 3 000 mm 3 001 ... 3 500 mm 3 501 ... 4 000 mm	G 0 G 1 G 2 G 3 G 4 G 5 G 6 G 7
<b>NOTE:</b> <b>When selecting a Rigid Extension option, extension coating must match the process connection coating and the material and surface roughness type.</b>		<b>Rigid Extension Monel</b> 80 ... 500 mm 501 ... 1 000 mm 1 001 ... 1 500 mm 1 501 ... 2 000 mm 2 001 ... 2 500 mm 2 501 ... 3 000 mm	H 0 H 1 H 2 H 3 H 4 H 5
<b>Rigid Extension 316L</b> 80 ... 500 mm 501 ... 1 000 mm 1 001 ... 1 500 mm 1 501 ... 2 000 mm 2 001 ... 2 500 mm 2 501 ... 3 000 mm 3 001 ... 3 500 mm 3 501 ... 4 000 mm	A 0 A 1 A 2 A 3 A 4 A 5 A 6 A 7	<sup>1)</sup> Available with Adapter/Process temperature options 1, 3, 4, and 5 only <sup>2)</sup> Available with Electronics option 4 only <sup>3)</sup> Available with Adapter/Process temperature options 1 and 3 only <sup>4)</sup> Extension length restricted to 2 956 mm <sup>5)</sup> Available with Housing/Cable entry option B only <sup>6)</sup> Available with Adapter/Process temperature options 1 and 4 only <sup>7)</sup> Available with Adapter/Process temperature options 1, 2, and 4 only <sup>8)</sup> Available with enamelled Process connection and Extension options only <sup>9)</sup> Available with Approval options A, B, C only <sup>10)</sup> Not available with SIL/IEC61508 Certificate of conformity (SIL-2 min. and max. detection)	
<b>Rigid Extension ECTFE coated<sup>6)</sup></b> 80 ... 500 mm 501 ... 1 000 mm 1 001 ... 1 500 mm 1 501 ... 2 000 mm 2 001 ... 2 500 mm 2 501 ... 3 000 mm	B 0 B 1 B 2 B 3 B 4 B 5		
<b>Rigid Extension PFA coated<sup>6)</sup></b> 80 ... 500 mm 501 ... 1 000 mm 1 001 ... 1 500 mm 1 501 ... 2 000 mm 2 001 ... 2 500 mm 2 501 ... 3 000 mm	C 0 C 1 C 2 C 3 C 4 C 5		
<b>Rigid Extension 316L Ra ≤ 0.8 µm</b> 80 ... 500 mm 501 ... 1 000 mm 1 001 ... 1 500 mm 1 501 ... 2 000 mm 2 001 ... 2 500 mm 2 501 ... 3 000 mm 3 001 ... 3 500 mm 3 501 ... 4 000 mm	D 0 D 1 D 2 D 3 D 4 D 5 D 6 D 7		
<b>Rigid Extension 316L Ra ≤ 0.3 µm</b> 80 ... 500 mm 501 ... 1 000 mm 1 001 ... 1 500 mm 1 501 ... 2 000 mm 2 001 ... 2 500 mm 2 501 ... 3 000 mm 3 001 ... 3 500 mm 3 501 ... 4 000 mm	E 0 E 1 E 2 E 3 E 4 E 5 E 6 E 7		

# Level measurement

## Point level measurement – Vibrating switches

### SITRANS LVL200

#### Selection and Ordering data

#### Order code

##### Further designs

Please add "-Z" to Article No. and specify Order code(s).

Cleaning including Certificate (oil, grease and silicone free)

**W01**

Enter the total insertion length in plain text description, max. 4 000 mm (157.48 inch)

**Y01**

Identification Label (measurement loop) stainless steel: max. 16 characters add in plain text

**Y17**

Identification Label (measurement loop) Foil: max. 16 characters add in plain text

**Y18**

Acceptance test certificate 3.1 NACE MR 0775 for material EN10204

**D07**

Acceptance test certificate 3.1 for instrument EN10204

**C12**

Acceptance test Certificate 2.2 for material EN10204

**C15**

Functional Safety (SIL 2). Device suitable for use in accordance with IEC 61508 and IEC 61511

**C20**

##### Additional Operating Instructions

Article No.

##### LVL200 Extended (DPDT Relay)

- English
- French
- Spanish
- German

**7ML1998-5KW01**

**7ML1998-5KW11**

**7ML1998-5KW21**

**7ML1998-5KW31**

##### LVL200 (Contactless electronic switch)

- English
- French
- Spanish
- German

**7ML1998-5KV01**

**7ML1998-5KV11**

**7ML1998-5KV21**

**7ML1998-5KV31**

##### Electronics module LVL200 Relay

- English
- French
- Spanish
- German

**7ML1998-5LS01**

**7ML1998-5LS11**

**7ML1998-5LS21**

**7ML1998-5LS31**

This device is shipped with the Siemens Milltronics manual DVD containing the Operating Instructions library.

##### Spare Parts and Accessories

Electronics module SITRANS LVL200 Relay

**7ML1830-1NC**

Electronics module SITRANS LVL200 Contactless

**7ML1930-6AA**

Lock fitting, unpressurized, G1" A/316L

**7ML1930-1DQ**

Lock fitting, unpressurized, 1" NPT/316L

**7ML1930-1DR**

Lock fitting, unpressurized, G1 ...1/2" A/316L

**7ML1930-1DS**

Lock fitting, unpressurized, 1 ... 1/2" NPT/316L

**7ML1930-1DT**

Lock fitting, -1... 16 bar, G1" A/316L

**7ML1930-1DU**

Lock fitting, -1... 16 bar, 1" NPT/316L

**7ML1930-1DV**

Lock fitting, -1... 16 bar, G1 ... 1/2" A/316L

**7ML1930-1DW**

Lock fitting, -1... 16 bar, 1 ... 1/2" NPT/316L

**7ML1930-1DX**

Lock fitting, -1... 64 bar, G1" A/316L

**7ML1930-1EA**

Lock fitting, -1... 64 bar, 1" NPT/316L

**7ML1930-1EB**

Lock fitting, -1... 64 bar, G1 ... 1/2" A/316L

**7ML1930-1EC**

Lock fitting, -1... 64 bar, 1 ... 1/2" NPT/316L

**7ML1930-1ED**

# Level measurement

## Point level measurement – Vibrating switches

SITRANS LVL200

### Options

#### LVL200 threaded welded socket

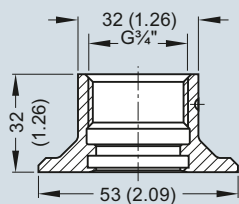
G $\frac{3}{4}$ " A/316L

G1" A/316L

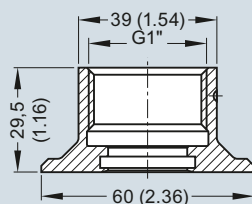

#### Lock fitting

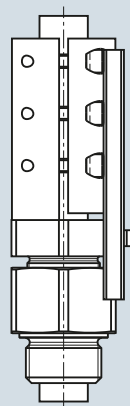
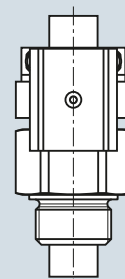
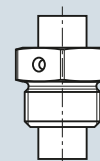
LVL200 extended  
64 barLVL200 extended  
16 barLVL200 extended  
unpressurized

SITRANS LVL200 welded socket and lock fitting, dimensions in mm (inch)



# Level measurement

## Point level measurement – Vibrating switches

### SITRANS LVL200

#### Characteristic curves

Ambient/Process temperature

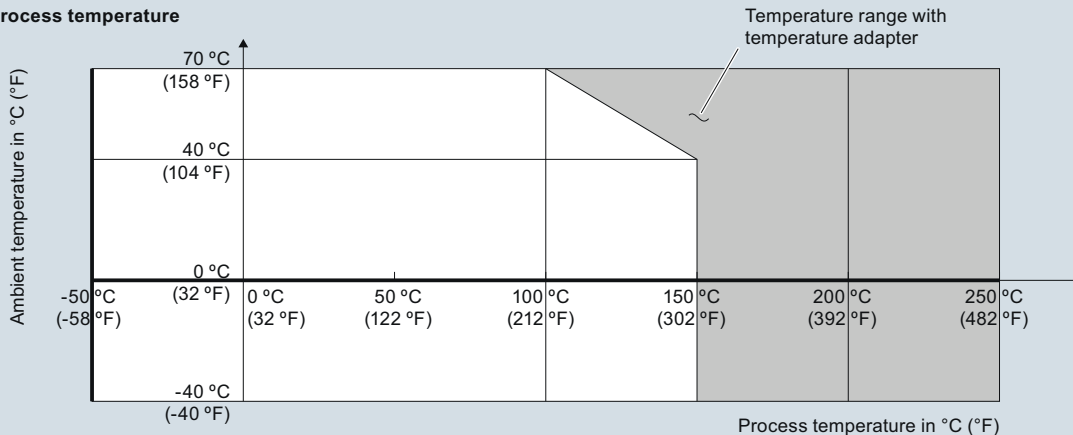

Process pressure with switch position 0.7 g/cm³ (mode switch)

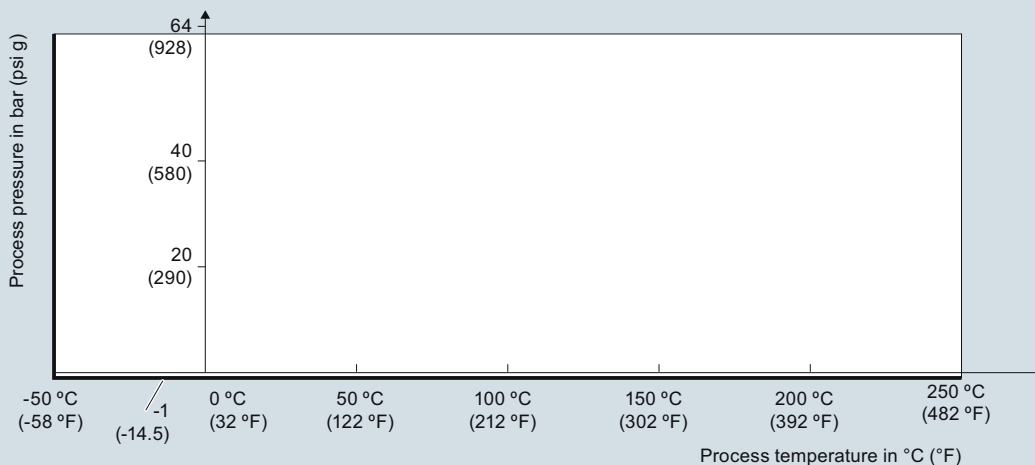

Process pressure with switch position 0.5 g/cm³ (mode switch)

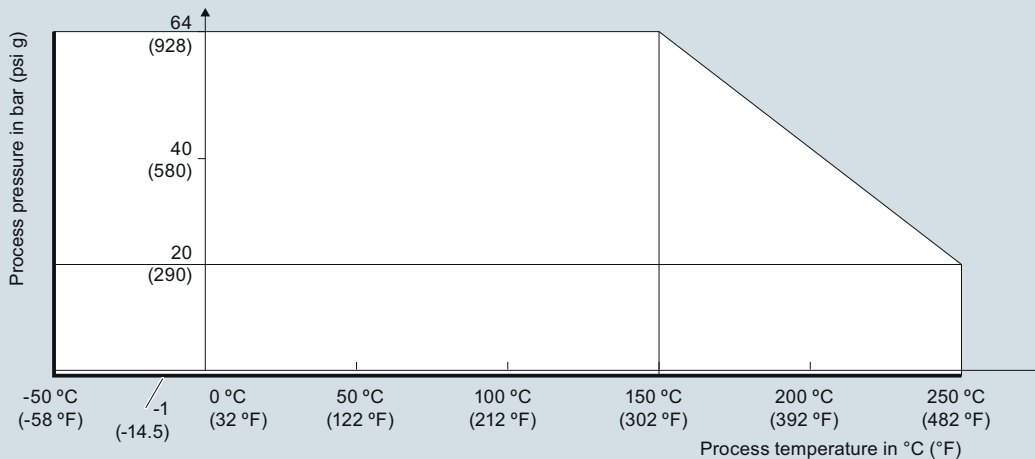

SITRANS LVL200 Process Pressure/Process Temperature/Ambient Temperature derating curves

4

# Level measurement

## Point level measurement – Vibrating switches

SITRANS LVL200

### Dimensional drawings

SITRANS LVL200 (Standard)

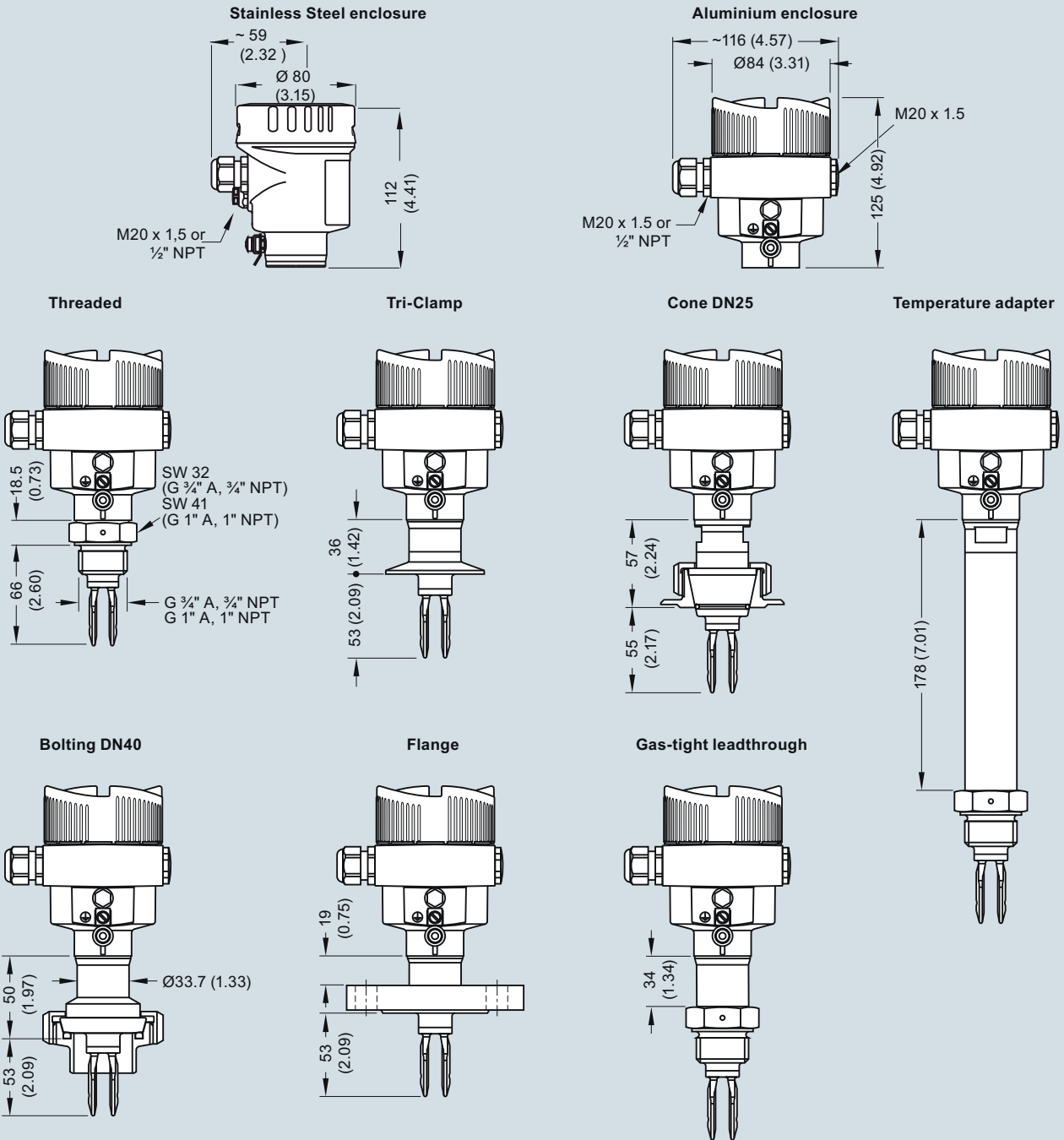

SITRANS LVL200 (Standard), dimensions in mm (inch)

# Level measurement

## Point level measurement – Vibrating switches

### SITRANS LVL200

SITRANS LVL200 (Extended)

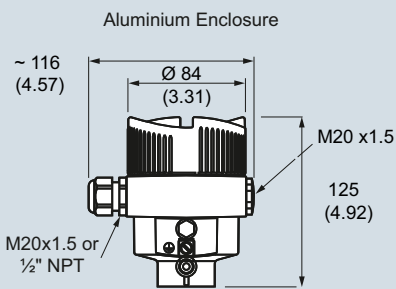
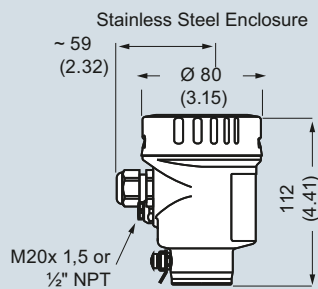

Sensor length (L)	
316L, Hastelloy C4 (2.4610)	80 ... 6 000 mm (3.15 ... 236.2 inch)
Hastelloy C4 (2.4610) enamelled	80 ... 1 500 mm (3.15 ... 59.06 inch)
316L, ECTFE coated	80 ... 3 000 mm (3.15 ... 118.1 inch)
316L, PFA coated	80 ... 3 000 mm (3.15 ... 118.1 inch)

4

Threaded

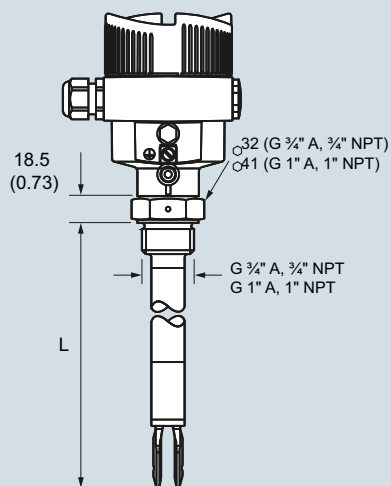

Tri-clamp

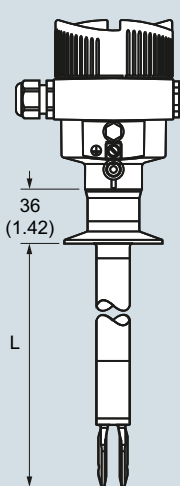

Cone DN 25

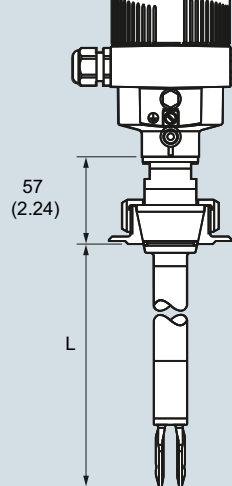

Bolting DN 40

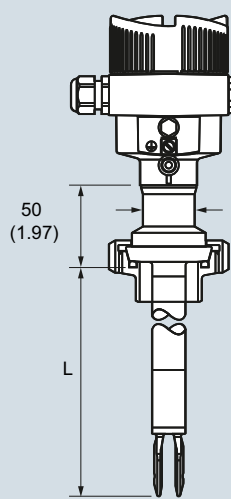

Flanged

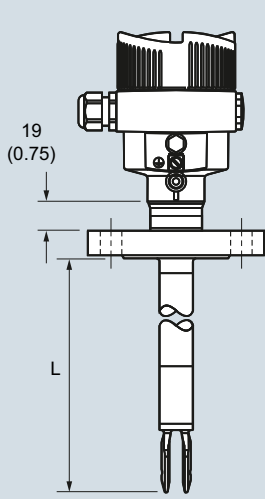

Gas-tight leadthrough

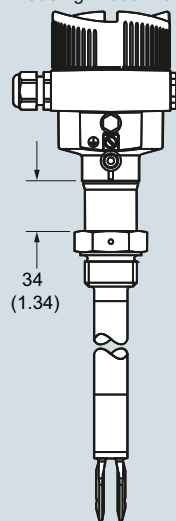

Temperature adapter

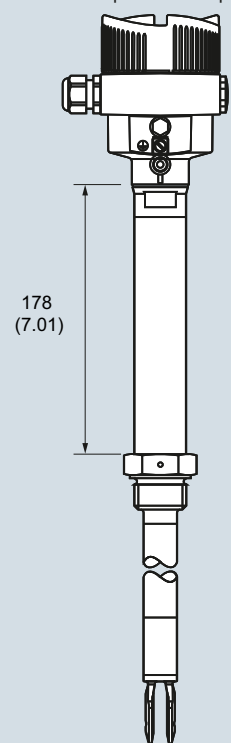

SITRANS LVL200 (Extended), dimensions in mm (inch)

# Level measurement

## Point level measurement – Vibrating switches

SITRANS LVL200

### Schematics

#### Relay (DPDT)

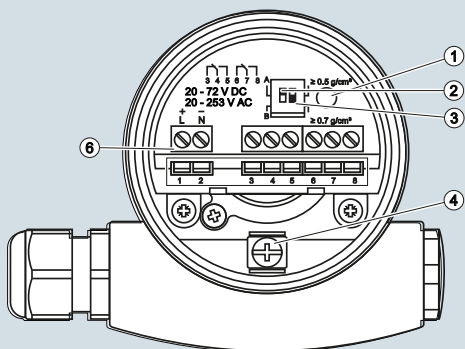

- |   |   |
|---|---|
| ① | Control lamp                            |
| ② | DIL switch for characteristics reversal |
| ③ | DIL switch for sensitivity adjustment   |
| ④ | Ground terminal                         |
| ⑤ | Connection terminals                    |

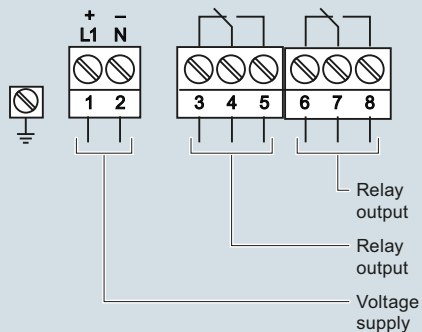

#### Contactless

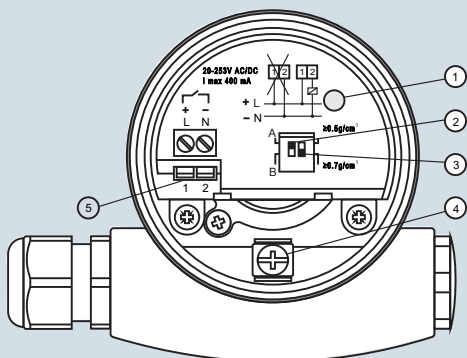

- |   |   |
|---|---|
| ① | Control lamp                              |
| ② | DIL switch for mode adjustment            |
| ③ | DIL switch for switching point adaptation |
| ④ | Ground terminal                           |
| ⑤ | Connection terminals                      |

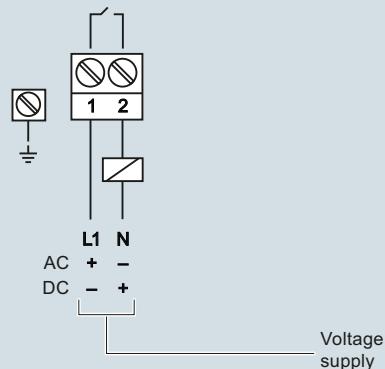

#### NAMUR

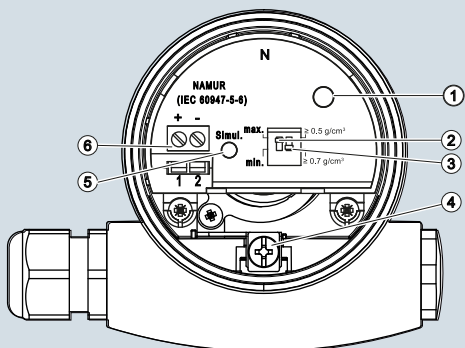

- |   |   |
|---|---|
| ① | Control lamp                            |
| ② | DIL switch for characteristics reversal |
| ③ | DIL switch for sensitivity adjustment   |
| ④ | Ground terminal                         |
| ⑥ | Simulation key                          |
| ⑤ | Connection terminals                    |

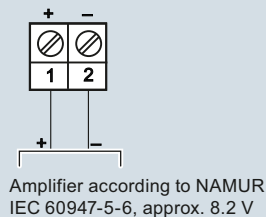

SITRANS LVL200 connections

4