



Table of contents

	Page
Specifications / Applications	P2

VN 4020 Short extension length	P4
	

VN 4030 Pipe extension	P6
	

Options	P8
Dimensions	P10
Spare parts	P11
Electrical installation	P12

Subject to change.

All dimensions in mm (inches).

All prices in Euro, excluding VAT.

All prices are EXW Betzigau, excluding packaging costs.

Valid: From 01.04.2013 until 31.03.2014, unless otherwise agreed.

By publishing this selection list all other lists become invalid.

We assume no liability for typing errors.

Different variations to those specified are possible.
 Please contact our technical consultants.

Specifications

- Level limit detection in bulk goods / solids
- Compact unit
- Die-casted housing aluminium
- Wide range of applications, no maintenance
- Full-, demand-, empty detector
- ATEX, IEC-Ex, FM, CSA approvals (DustEx)
- GOST-R and RTN Ex approvals (DustEx)
- 1935/2004/EC Food grade materials
- Sensitivity > 30 g/l (1.9lb/ft³)

Approvals	CE	
	ATEX / IEC-Ex	Zone 20/21 (Dust Ignition Proof)
	FM / CSA	General purpose
		Cl. II, III Div. 1 (Dust Ignition Proof)
GOST-R / RTN Ex	Dust Ignition Proof	

Electronics	Relay DPDT	19..230V AC 19..40V DC ± 10%
	PNP	18..50V DC ± 10%

VN 4020	Length of extension	170mm (6.68")
	Ambient temperature	-40 .. +60°C (-40 .. +140°F)
	Process temperature	-40 .. +150°C (-40 .. +302°F)
	Process pressure	-1 .. +16 bar (-14.5 .. +232 psi)
	Process connection material / Extension	1.4581 (SS 316) (food grade)

VN 4030	Length of extension	300 .. 4.000mm (11.8 .. 157")
	Ambient temperature	-40 .. +60°C (-40 .. +140°F)
	Process temperature	-40 .. +150°C (-40 .. +302°F)
	Process pressure	-1 .. +16 bar (-14.5 .. +232 psi)
	Process connection material / Extension	1.4301 (SS 304) or 1.4571 (SS 316) (food grade)

VN 4020



VN 4030



Applications

Detection of solids

VN 4020

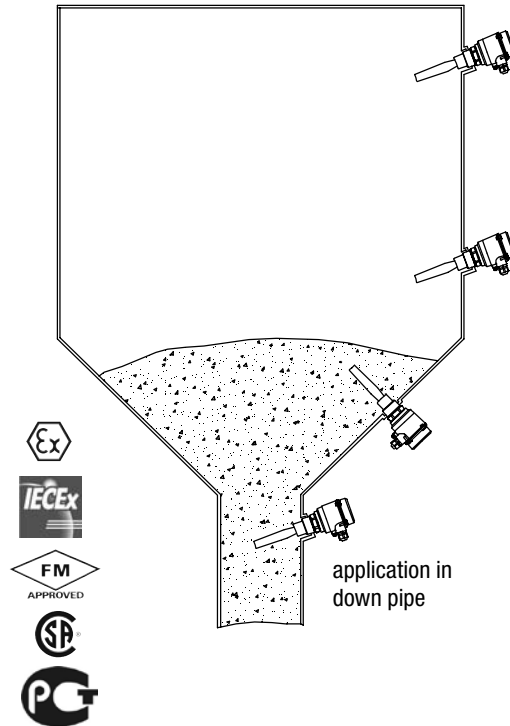

VN 4030

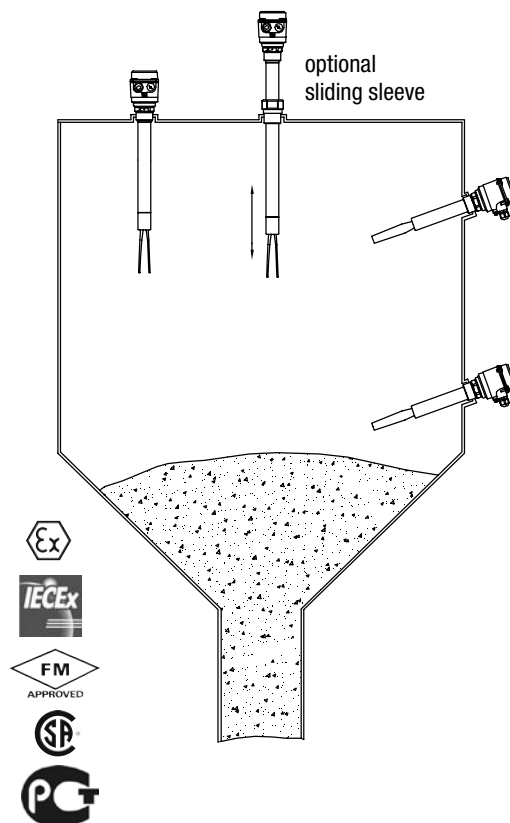

VN 4020 Short extension length



Food grade materials

Cable entries (by default)

Depending on model selected the following cable entries are supported (options see pos 23 on page 8):

Version:	Cable entries:
CE / ATEX / IEC-Ex (pos.2 0,W, F)	M20x1,5 (1x cable gland + 1x blind plug)
FM and CSA (pos.2 M,N)	NPT 1/2" tapered ANSI B1.20.1 (1x open conduit + 1x blind plug)

Dimensions see page 10

pos. 3
 Temperature extended shaft

Application up to 150°C (302°F)

- 1 without
- 2 with

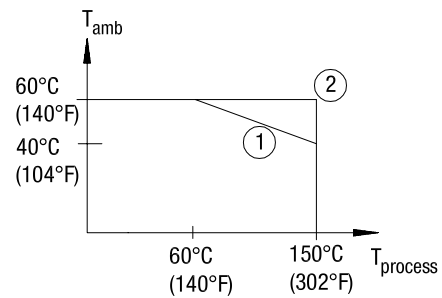
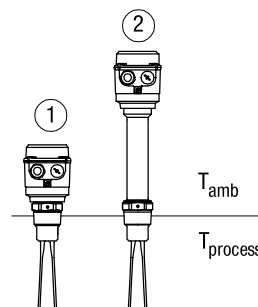

VN 4020 Short extension length

Basic type

VN 4020

- pos. 2 **Certificate**
- 0 CE ⁽¹⁾
 - W ATEX II 1/2D ⁽²⁾ Ex t III C T! Da/Db IP6X
 - A IEC-Ex t III C T! Da/Db IP6X
 - M FM / CSA General Purpose
 - N FM / CSA DIP Cl. II, III Div.1 Groupe E, F, G and CSA DIP A20/21

- pos. 3 **Temperature extended shaft**
- 1 without (up to $T_{process} = 150^{\circ}\text{C}$ (302°F) bei $T_{amb} < 40^{\circ}\text{C}$ (104°F))
 - 2 with (up to $T_{process} = 150^{\circ}\text{C}$ (302°F) bei $T_{amb} > 40^{\circ}\text{C}$ (104°F))

- pos. 4 **Electronic module**
- L Relay DPDT 19..230V AC 19..40V DC
 - D PNP 18..50V DC

- pos. 5 **Process connection**
- A Thread R 1½ inch, conical DIN 2999
 - B Thread NPT 1½ inch, conical ANSI B1.20.1
 - D Thread NPT 1 ¼ inch, conical ANSI B1.20.1
 - L Flange DN 100 PN6, EN1092-1 (max. 6 bar (87psi))
 - M Flange DN 100 PN16, EN1092-1
 - S Flange 2" 150lbs ANSI B16.5
 - T Flange 3" 150lbs ANSI B16.5
 - U Flange 4" 150lbs ANSI B16.5

- pos. 8 **Material of process connection / extension "L"**
- 1 Stainless steel 1.4301 (304)
 - 2 Stainless steel 1.4571 (316Ti)/1.4404 (316L)

Further options: see page 8

VN 4020	A					3	1	
position	1	2	3	4	5	6	7	8

← **Order code**

All positions are available in special design (use code "Z").

⁽¹⁾ GOST-R included

⁽²⁾ RTN-Ex and GOST-R included

VN 4030 Pipe extension



Food grade materials

Cable entries (by default)

Depending on model selected the following cable entries are supported (options see pos 23 on page 8):

Version:	Cable entries:
CE / ATEX / IEC-Ex (pos.2 O,W, F)	M20x1,5 (1x cable gland + 1x blind plug)
FM and CSA (pos.2 M,N)	NPT 1/2" tapered ANSI B1.20.1 (1x open conduit + 1x blind plug)

Dimensions

see page 10

pos. 3

Temperature extended shaft

Application up to 150°C (302°F)

- 1 without
- 2 without and with extended socket
- 3 with

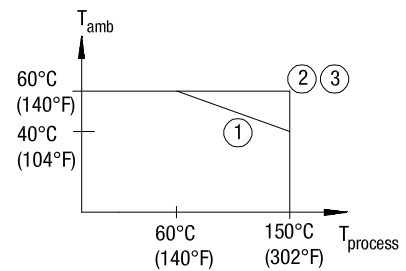
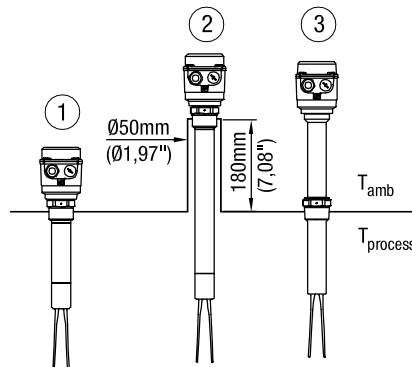

VN 4030 Pipe extension

Basic type

VN 4030

- pos. 2 **Certificate**
- 0 CE ⁽¹⁾
 - W ATEX II 1/2D ⁽²⁾ Ex t III C T! Da/Db IP6X
 - A IEC-Ex t III C T! Da/Db IP6X
 - M FM / CSA General Purpose
 - N FM / CSA DIP Cl. II, III Div.1 Groupe E, F, G and CSA DIP A20/21

- pos. 3 **Temperature extended shaft**
- 1 without (up to $T_{process} = 150^{\circ}C$ (302°F) bei $T_{amb} < 40^{\circ}C$ (104°F))
 - 2 with (up to $T_{process} = 150^{\circ}C$ (302°F) bei $T_{amb} > 40^{\circ}C$ (104°F))

- pos. 4 **Electronic module**
- L Relay DPDT 19..230V AC 19..40V DC
 - D PNP 18..50V DC

- pos. 5 **Process connection**
- A Thread R 1½ inch, conical DIN 2999
 - B Thread NPT 1½ inch, conical ANSI B1.20.1
 - D Thread NPT 1 ¼ inch, conical ANSI B1.20.1
 - L Flange DN 100 PN6, EN1092-1 (max. 6 bar (87psi))
 - M Flange DN 100 PN16, EN1092-1
 - S Flange 2" 150lbs ANSI B16.5
 - T Flange 3" 150lbs ANSI B16.5
 - U Flange 4" 150lbs ANSI B16.5

- pos. 7 **Length of extension "L"**
- Z from 0mm per 100mm (3.94") and part thereof; min. 300mm (11.8"), max. 4.000mm (157")

- pos. 8 **Material of process connection / extension "L"**
- 1 Stainless steel 1.4301 (304)
 - 2 Stainless steel 1.4571 (316Ti)/1.4404 (316L)

Further options: see page 8

VN 4030	B					3	Z			-	L=	mm	← Order code
position	1	2	3	4	5	6	7	8					

All positions are available in special design (use code "Z").

⁽¹⁾ GOST-R included
⁽²⁾ RTN-Ex and GOST-R included

Options

pos. 21 **Weather protection cover**
 (for Ex only approved for Zone 22 or Div. 2)

Mounting set for flange mounting

process connection flange	for counter flange with	consists of			
		screws*	nuts*	washers*	sealing**
pos. 22c L	hole ø18	4 x M16x60	4 x M16	4 pcs	1 piece
pos. 22d L	thread M16	4 x M16x40		4 pcs	1 piece
pos. 22e M	hole ø18	4 x M16x60	8 x M16	8 pcs	1 piece
pos. 22f M	thread M16	4 x M16x40		8 pcs	1 piece

* material stainless steel A2 **max. 125°C (256°F), material not food grade

Cable entry

Selection of the following options only necessary, if a deviation from the default cable gland / conduit is required:

pos. 23x M20x1.5 2x screwed cable gland
 pos. 23y M20x1.5 1x screwed cable gland +1x blind plug
 pos. 23a NPT 1/2" tapered ANSI B1.20.1 (1x conduit + 1x Ex-d blind plug)
 pos. 23b NPT 3/4" tapered ANSI B1.20.1 (1x conduit + 1x Ex-d blind plug) on request

Sliding sleeve

Process connection as follows or flange as choosen

³ For applications without overpressure, max. 150°C (302°F), Available not for Ex (Pos.2 W,N)

pos. 25a R 1½ inch DIN 2999 material 1.4301 (304)
 pos. 25b NPT 1½ inch ANSI B1.20.1 material 1.4301 (304)

For applications with overpressure max. 16bar (232psi), max. 150°C (302°F)

pos. 25e R 1½ inch DIN 2999 material 1.4571 (316 TI)
 pos. 25f NPT 1½ inch ANSI B1.20.1 material 1.4571 (316 TI)

Signal lamp

pos. 27a Bulb in cable gland, 2W green ¹
 pos. 27c Bulb in cable gland, 2W red ¹
 pos. 27b LED (glass window in lid)⁴

pos. 29 **Plug 4-pole ² (incl. PE)**

¹ Available for CE (pos. 2, 0), not in combination with weather protection cover (pos. 21) and cable entries pos.23 x,a,b.
 For electronic module Relais DPDT (pos. 4.L) three bulbs (24V, 115V and 230V) will be delivered. For PNP (pos.4.D) a 24V bulb will be delivered.

² Available only for CE (pos. 2, 0)

³ Available for CE and FM/CSA general purpose (pos. 2, 0, M)

⁴ Not with weather protection cover (Pos. 21)

Options

pos. 21
Weather protection cover

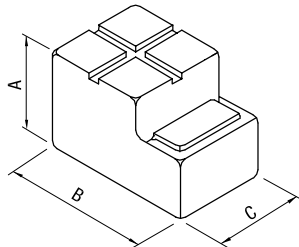

	With CE, ATEX, IEC-Ex	With FM, CSA
A	100mm (3.94")	130mm (5.12")
B	165mm (6.5")	200mm (7.87")
C	88mm (3.46")	125mm (4.92")

pos. 25
Sliding sleeve

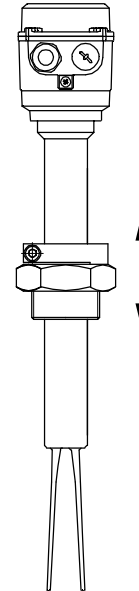

pos. 29
Plug 4-pole

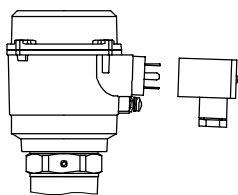

Signal lamp

pos. 27a, c
 Bulb in cable gland

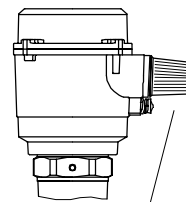

bulb

pos. 27b
 LED (glass window in lid)

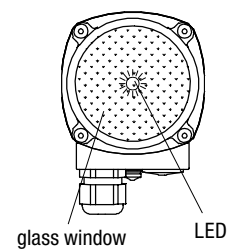

glass window

LED

Dimensions

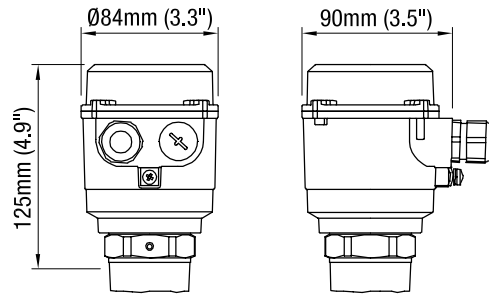

VN 4020

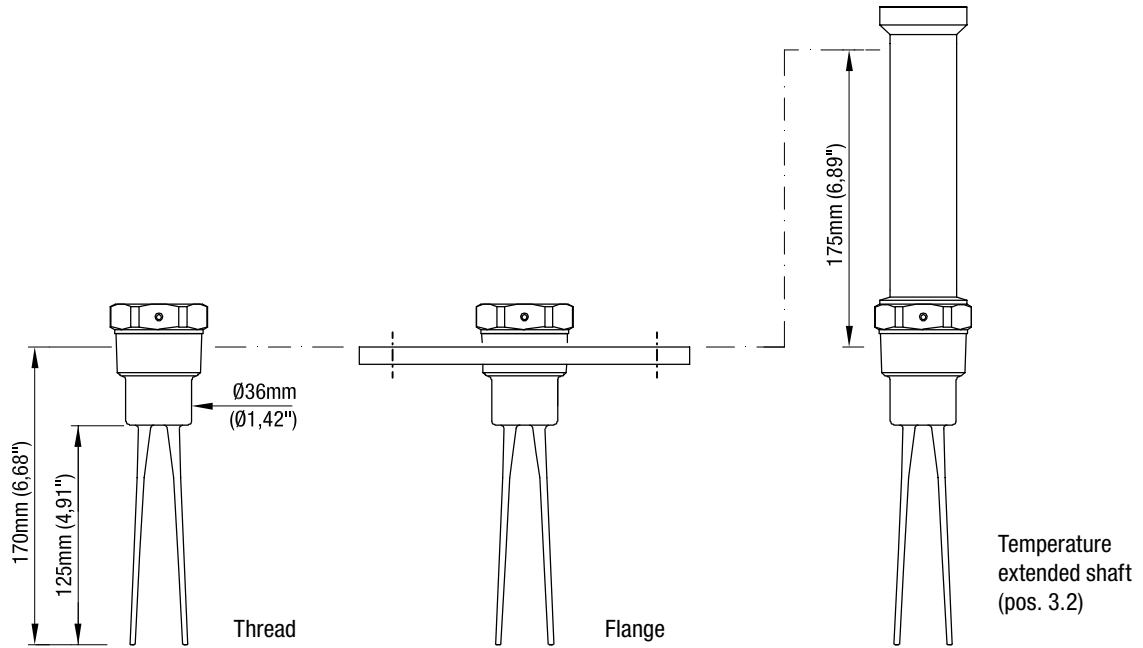

VN 4030

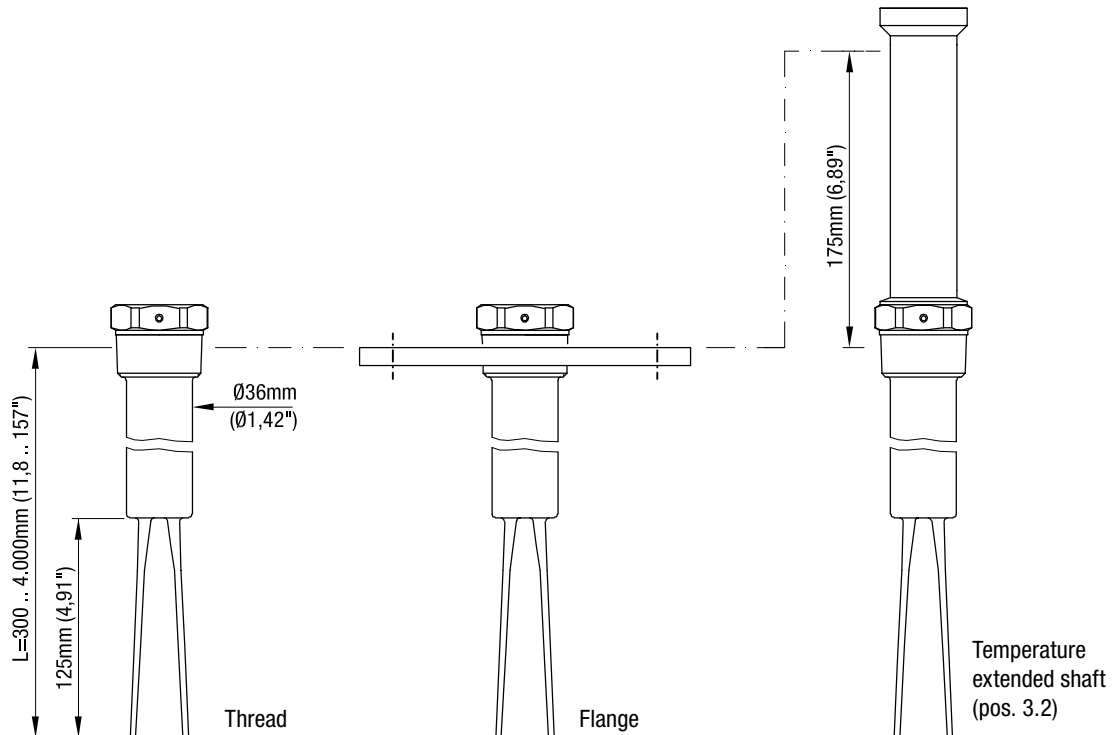

Dimensions / Spare parts

Flanges

code	type	number of holes	d2	Lk	D	T (thickness)
L	flange DN100 PN6	4	18mm (0.71")	170mm (6.69")	210mm (8.27")	16mm (0.63")
M	flange DN100 PN16	8	18mm (0.71")	180mm (7.09")	220mm (8.66")	20mm (0.79")
S	flange 2" 150lbs	4	19.1mm (0.75")	120.7mm (4.75")	152.4mm (6.01")	19.1mm (0.75")
T	flange 3" 150lbs	4	19.1mm (0.75")	152.4mm (6.01")	190.5mm (7.5")	23.9mm (0.94")
U	flange 4" 150lbs	8	19.1mm (0.75")	190.5mm (7.5")	228.6mm (9")	23.9mm (0.94")

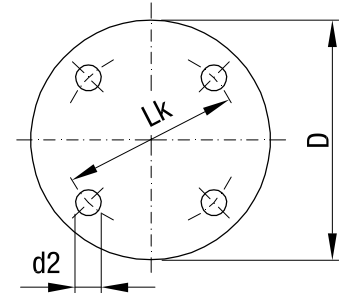

Spare parts

Electronic board	Article number	Price
Relais DPDT 19..230V AC 19..50V DC	pl408265	
PNP 18..50V DC	pl408266	

Electronic board

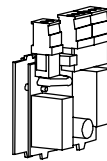

Fitting for housing

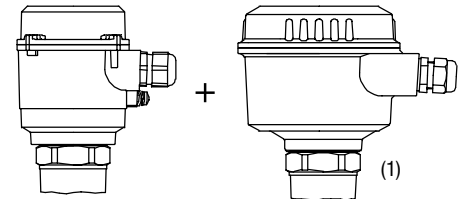

(1) Adapting plate included

Electrical installation

Universal voltage

Relay DPDT

Power supply:

19..230V 50-60Hz ± 10%* 22VA

19..40V DC ± 10%* 2W

*incl. ±10% of EN 61010

Fuse on power supply:

max. 10A, fast or slow, HBC, 250V

Signal output:

Floating relay DPDT

AC max. 250V, 8A, non inductive

DC max. 30V, 5A, non inductive

Fuse on signal output:

max 10A, fast or slow, HBC, 250V

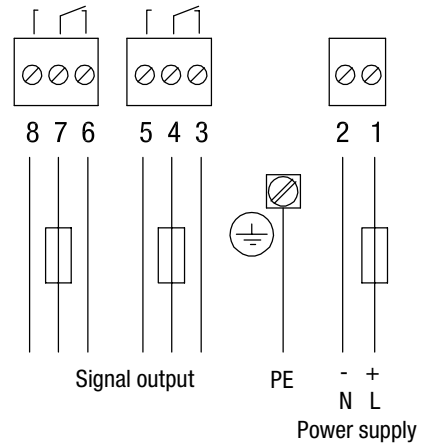

3-wire

PNP

Power supply:

18 .. 50V DC ±10%*

*incl. ±10% of EN 61010

Input current: max. 0.5A

Fuse:

max. 4A, fast or slow, 250V

Signal output:

max. 0.4A

Output voltage equal to input
 voltage, drop <2.5V

Load for example:

PLC, relay, contactor, bulb

