

# Temperature Measurement

## Transmitters for rail mounting

SITRANS TR200  
two-wire system, universal

2

### Overview



#### Ultra flexible - with the universal SITRANS TR200 transmitter

- Two-wire devices for 4 to 20 mA
- Enclosure for rail mounting
- Universal input for virtually any type of temperature sensor
- Configurable over PC

### Benefits

- Compact design
- Electrically isolated
- Test sockets for multimeters
- Diagnostics LED (green/red)
- Sensor monitoring open circuits and short-circuits
- Self-monitoring
- Configuration status stored in EEPROM
- Expanded diagnostic functions, such as slave pointer, operating hours counter, etc.
- Special characteristic
- Electromagnetic compatibility to EN 61326 and NE21
- SIL2 (with Order Code C20), SIL2/3 (with C23)

### Application

SITRANS TR200 transmitters can be used in all industrial sectors. Their compact design enables simple mounting on standard DIN rails on-site in protective boxes or in control cabinets. The following sensors/signal sources can be connected over their universal input module:

- Resistance thermometers (2, 3 or 4-wire system)
- Thermocouples
- Resistance-based sensors and DC voltage sources

The output signal is a direct current from 4 to 20 mA in accordance with the sensor characteristic.

Transmitters of the "intrinsically safe" type of protection can be installed within potentially explosive atmospheres. The devices comply with the Directive 94/9/EC (ATEX).

### Function

The SITRANS TR200 is configured over a PC. A USB or RS 232 modem is linked to the output terminals for this purpose. The configuration data can now be edited using the SIPROM T software tool. The configuration data are then permanently stored in the non-volatile memory (EEPROM).

Once the sensors and power supply have been correctly connected, the transmitter outputs a temperature-linear output signal and the diagnostics LED displays a green light. In the case of a sensor short-circuit, the LED flashes red, an internal device fault is indicated by a steady red light.

The test socket can be used to connect an ammeter at any time for monitoring purposes and plausibility checks. The output current can be read without any interruption, or even without opening the current loop.

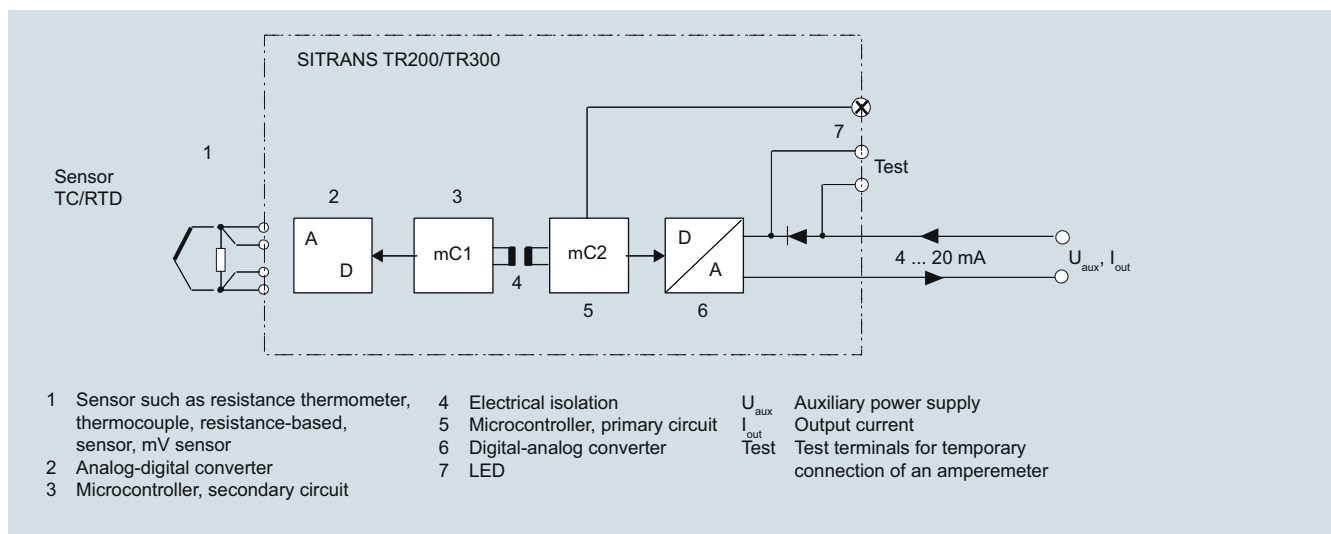

SITRANS TR200 function diagram

# Temperature Measurement

## Transmitters for rail mounting

### SITRANS TR200

#### two-wire system, universal

#### Technical specifications

##### Input

##### Resistance thermometer

Measured variable	Temperature
Sensor type	<ul style="list-style-type: none"> <li>• to IEC 60751</li> <li>• to JIS C 1604; <math>a=0.00392 \text{ K}^{-1}</math></li> <li>• to IEC 60751</li> <li>• Special type</li> </ul>
Sensor factor	0.25 ... 10 (adaptation of the basic type, e.g. Pt100 to version Pt25 ... 1000)
Units	°C or °F
Connection	
• Standard connection	1 resistance thermometer (RTD) in 2-wire, 3-wire or 4-wire system
• Generation of average value	2 resistance thermometers in 2-wire system for generation of average temperature
• Generation of difference	2 resistance thermometers (RTD) in 2-wire system (RTD 1 – RTD 2 or RTD 2 – RTD 1)
Interface	
• Two-wire system	Parameterizable line resistance $\leq 100 \Omega$ (loop resistance)
• Three-wire system	No balancing required
• Four-wire system	No balancing required
Sensor current	$\leq 0.45 \text{ mA}$
Response time $T_{63}$	$\leq 250 \text{ ms}$ for 1 sensor with open-circuit monitoring
Open-circuit monitoring	Always active (cannot be disabled)
Short-circuit monitoring	can be switched on/off (default value: ON)
Measuring range	parameterizable (see table "Digital measuring errors")
Min. measured span	10 °C (18 °F)
Characteristic curve	Temperature-linear or special characteristic

##### Resistance-based sensors

Measured variable	Actual resistance
Sensor type	Resistance-based, potentiometers
Units	$\Omega$
Connection	
• Normal connection	1 resistance-based sensor (R) in 2-wire, 3-wire or 4-wire system
• Generation of average value	2 resistance-based sensors in 2-wire system for generation of average value
• Generation of difference	2 resistance thermometers in 2-wire system (R1 – R2 or R2 – R1)
Interface	
• Two-wire system	Parameterizable line resistance $\leq 100 \Omega$ (loop resistance)
• Three-wire system	No balancing required
• Four-wire system	No balancing required
Sensor current	$\leq 0.45 \text{ mA}$
Response time $T_{63}$	$\leq 250 \text{ ms}$ for 1 sensor with open-circuit monitoring
Open-circuit monitoring	Always active (cannot be disabled)

##### Short-circuit monitoring

Short-circuit monitoring	can be switched on/off (default value: OFF)
Measuring range	parameterizable max. 0 ... 2200 $\Omega$ (see table "Digital measuring errors")
Min. measured span	5 ... 25 $\Omega$ (see table "Digital measuring errors")
Characteristic curve	Resistance-linear or special characteristic

##### Thermocouples

Measured variable	Temperature
Sensor type (thermocouples)	
• Type B	Pt30Rh-Pt6Rh to DIN IEC 584
• Type C	W5 %-Re acc. to ASTM 988
• Type D	W3 %-Re acc. to ASTM 988
• Type E	NiCr-CuNi to DIN IEC 584
• Type J	Fe-CuNi to DIN IEC 584
• Type K	NiCr-Ni to DIN IEC 584
• Type L	Fe-CuNi to DIN 43710
• Type N	NiCrSi-NiSi to DIN IEC 584
• Type R	Pt13Rh-Pt to DIN IEC 584
• Type S	Pt10Rh-Pt to DIN IEC 584
• Type T	Cu-CuNi to DIN IEC 584
• Type U	Cu-CuNi to DIN 43710
Units	°C or °F
Connection	
• Standard connection	1 thermocouple (TC)
• Generation of average value	2 thermocouples (TC)
• Generation of difference	2 thermocouples (TC) (TC1 – TC2 or TC2 – TC1)
Response time $T_{63}$	$\leq 250 \text{ ms}$ for 1 sensor with open-circuit monitoring
Open-circuit monitoring	Can be switched off
Cold junction compensation	
• Internal	With integrated Pt100 resistance thermometer
• External	With external Pt100 IEC 60571 (2-wire or 3-wire connection)
• External fixed	Cold junction temperature can be set as fixed value
Measuring range	parameterizable (see table "Digital measuring errors")
Min. measured span	Min. 40 ... 100 °C (72 ... 180 °F) (see table "Digital measuring errors")
Characteristic curve	Temperature-linear or special characteristic

##### mV sensor

Measured variable	DC voltage
Sensor type	DC voltage source (DC voltage source possible over an externally connected resistor)
Units	mV
Response time $T_{63}$	$\leq 250 \text{ ms}$ for 1 sensor with open-circuit monitoring
Open-circuit monitoring	Can be switched off
Measuring range	parameterizable max. - 100 ... 1100 mV
Min. measured span	2 mV or 20 mV
Overload capability of the input	-1.5 ... +3.5 V DC
Input resistance	$\geq 1 \text{ M}\Omega$
Characteristic curve	Voltage-linear or special characteristic

# Temperature Measurement

## Transmitters for rail mounting

**SITRANS TR200**  
two-wire system, universal

2

<b>Output</b>	
Output signal	4 ... 20 mA, 2-wire
Auxiliary power	11 ... 35 V DC (to 30 V for Ex i/ic; to 32 V for Ex nA)
Max. load	$(U_{aux} - 11 V)/0.023 A$
Overrange	3.6 ... 23 mA, infinitely adjustable (default range: 3.84 mA ... 20.5 mA)
Error signal (e.g. following sensor fault) (conforming to NE43)	3.6 ... 23 mA, infinitely adjustable (default value: 22.8 mA)
Sample cycle	0.25 s nominal
Damping	Software filter 1st order 0 ... 30 s (parameterizable)
Protection	Against reversed polarity
Electrically isolated	Input against output 2.12 kV DC (1.5 kV <sub>eff</sub> AC)
<b>Measuring accuracy</b>	
Digital measuring errors	See Table "Digital measuring errors"
Reference conditions	
• Auxiliary power	24 V ± 1 %
• Load	500 Ω
• Ambient temperature	23 °C
• Warming-up time	> 5 min
Error in the analog output (digital/analog converter)	< 0.025 % of span
Error due to internal cold junction	< 0.5 °C (0.9 °F)
Influence of ambient temperature	
• Analog measuring error	0.02 % of span/10 °C (18 °F)
• Digital measuring errors	
- With resistance thermometer	0.06 °C (0.11 °F)/10 °C (18 °F)
- with thermocouples	0.6 °C (1.1 °F)/10 °C (18 °F)
Auxiliary power effect	< 0.001 % of span/V
Effect of load impedance	< 0.002 % of span/100 Ω
Long-term drift	
• In the first month	< 0.02 % of span in the first month
• After one year	< 0.2 % of span after one year
• After 5 years	< 0.3 % of span after 5 years
<b>Conditions of use</b>	
<u>Ambient conditions</u>	
Ambient temperature range	-40 ... +85 °C (-40 ... +185 °F)
Storage temperature range	-40 ... +85 °C (-40 ... +185 °F)
Relative humidity	< 98 %, with condensation
Electromagnetic compatibility	acc. to EN 61326 and NE21
<b>Construction</b>	
Material	Plastic, electronic module potted
Weight	122 g
Dimensions	See "Dimensional drawings"
Cross-section of cables	Max. 2.5 mm <sup>2</sup> (AWG 13)
Degree of protection to IEC 60529	
• Enclosure	IP20

### Certificates and approvals

Explosion protection ATEX	
EC type test certificate	PTB 07 ATEX 2032X
• "Intrinsic safety" type of protection	II 2(1) G Ex ia/ib IIC T6/T4 II 3(1) G Ex ia/ic IIC T6/T4 II 3 G Ex ic IIC T6/T4 II 2(1) D Ex iaD/ibD 20/21 T115 °C
• Type of protection, "equipment is non-arcing"	II 3 G Ex nA IIC T6/T4
Other certificates	NEPSI

### Software requirements for SIPROM T

PC operating system	Windows ME, 2000, XP and Win 7 (32 bit); can also be used in connection with RS 232 modem under Windows 95, 98 and 98SE
---------------------	---

### Factory setting:

- Pt100 (IEC 751) with 3-wire circuit
- Measuring range: 0 ... 100 °C (32 ... 212 °F)
- Error signal in the event of sensor breakage: 22.8 mA
- Sensor offset: 0 °C (0 °F)
- Damping 0.0 s

### Digital measuring errors

#### Resistance thermometer

Input	Measuring range °C/(°F)	Min. measured span		Digital accuracy	
		°C	(°F)	°C	(°F)
<b>to IEC 60751</b>					
Pt25	-200 ... +850 (-328 ... +1562)	10	(18)	0.3	(0.54)
Pt50	-200 ... +850 (-328 ... +1562)	10	(18)	0.15	(0.27)
Pt100 ... Pt200	-200 ... +850 (-328 ... +1562)	10	(18)	0.1	(0.18)
Pt500	-200 ... +850 (-328 ... +1562)	10	(18)	0.15	(0.27)
Pt1000	-200 ... +350 (-328 ... +662)	10	(18)	0.15	(0.27)
<b>to JIS C1604-81</b>					
Pt25	-200 ... +649 (-328 ... +1200)	10	(18)	0.3	(0.54)
Pt50	-200 ... +649 (-328 ... +1200)	10	(18)	0.15	(0.27)
Pt100 ... Pt200	-200 ... +649 (-328 ... +1200)	10	(18)	0.1	(0.18)
Pt500	-200 ... +649 (-328 ... +1200)	10	(18)	0.15	(0.27)
Pt1000	-200 ... +350 (-328 ... +662)	10	(18)	0.15	(0.27)
Ni 25 to Ni1000	-60 ... +250 (-76 ... +482)	10	(18)	0.1	(0.18)

# Temperature Measurement

## Transmitters for rail mounting

### SITRANS TR200 two-wire system, universal

#### Resistance-based sensors

Input	Measuring range	Min. measured span	Digital accuracy
	$\Omega$	$\Omega$	$\Omega$
Resistance	0 ... 390	5	0.05
Resistance	0 ... 2200	25	0.25

#### Thermocouples

Input	Measuring range	Min. measured span	Digital accuracy
	$^{\circ}\text{C}/(^{\circ}\text{F})$	$^{\circ}\text{C}$ ( $^{\circ}\text{F}$ )	$^{\circ}\text{C}$ ( $^{\circ}\text{F}$ )
Type B	0 ... 1820 (32 ... 3308)	100 (180)	2 <sup>1)</sup> (3.6) <sup>1)</sup>
Type C (W5)	0 ... 2300 (32 ... 4172)	100 (180)	2 (3.6)
Type D (W3)	0 ... 2300 (32 ... 4172)	100 (180)	1 <sup>2)</sup> (1.8) <sup>2)</sup>
Type E	-200 ... +1000 (-328 ... +1832)	50 (90)	1 (1.8)
Type J	-210 ... +1200 (-346 ... +2192)	50 (90)	1 (1.8)
Type K	-230 ... +1370 (-382 ... +2498)	50 (90)	1 (1.8)
Type L	-200 ... +900 (-328 ... +1652)	50 (90)	1 (1.8)
Type N	-200 ... +1300 (-328 ... +2372)	50 (90)	1 (1.8)
Type R	-50 ... +1760 (-58 ... +3200)	100 (180)	2 (3.6)
Type S	-50 ... +1760 (-58 ... +3200)	100 (180)	2 (3.6)
Type T	-200 ... +400 (-328 ... +752)	40 (72)	1 (1.8)
Type U	-200 ... +600 (-328 ... +1112)	50 (90)	2 (3.6)

<sup>1)</sup> The digital accuracy in the range 0 to 300 °C (32 to 572 °F) is 3 °C (5.4 °F).

<sup>2)</sup> The digital accuracy in the range 1750 to 2300 °C (3182 to 4172 °F) is 2 °C (3.6 °F).

#### mV sensor

Input	Measuring range	Min. measured span	Digital accuracy
	mV	mV	$\mu\text{V}$
mV sensor	-10 ... +70	2	40
mV sensor	-100 ... +1100	20	400

The digital accuracy is the accuracy after the analog/digital conversion including linearization and calculation of the measured value.

An additional error is generated in the output current 4 to 20 mA as a result of the digital/analog conversion of 0.025 % of the set span (digital-analog error).

The total error under reference conditions at the analog output is the sum from the digital error and the digital-analog error (poss. with the addition of cold junction errors in the case of thermocouple measurements).

# Temperature Measurement

## Transmitters for rail mounting

**SITRANS TR200**  
two-wire system, universal

Selection and Ordering data	Article No.
<b>Temperature transmitter SITRANS TR200</b>	
For mounting on a standard DIN rail, two-wire system, 4 to 20 mA, programmable, with electrical isolation, with documentation on CD	
<ul style="list-style-type: none"> <li>Without explosion protection ▶ ◆ <b>7NG3032-0JN00</b></li> <li>With explosion protection to ATEX ▶ ◆ <b>7NG3032-1JN00</b></li> </ul>	
<b>Further designs</b>	Order code
Please add " <b>-Z</b> " to Article No. with and specify Order codes(s).	
With test protocol (5 measuring points)	<b>C11</b>
Functional safety SIL2	<b>C20</b>
Functional safety SIL2/3	<b>C23</b>
<b>Customer-specific programming</b>	
Add " <b>-Z</b> " to Article No. and specify Order code(s)	
Measuring range to be set Enter in plain text (max. 5 digits): Y01: ... to ... °C, °F	<b>Y01<sup>1)</sup></b>
Measuring point no. (TAG), max. 8 characters	<b>Y17</b>
Measuring point descriptor, max. 16 characters	<b>Y23</b>
Measuring point message, max. 32 characters	<b>Y24</b>
Text on front label, max. 16 characters	<b>Y29<sup>2)</sup></b>
Pt100 (IEC) 2-wire, $R_L = 0 \Omega$	<b>U02</b>
Pt100 (IEC) 3-wire	<b>U03</b>
Pt100 (IEC) 4-wire	<b>U04</b>
Thermocouple type B	<b>U20</b>
Thermocouple type C (W5)	<b>U21</b>
Thermocouple type D (W3)	<b>U22</b>
Thermocouple type E	<b>U23</b>
Thermocouple type J	<b>U24</b>
Thermocouple type K	<b>U25</b>
Thermocouple type L	<b>U26</b>
Thermocouple type N	<b>U27</b>
Thermocouple type R	<b>U28</b>
Thermocouple type S	<b>U29</b>
Thermocouple type T	<b>U30</b>
Thermocouple type U	<b>U31</b>
With TC: CJC internal	<b>U40</b>
With TC: CJC external (Pt100, 3-wire)	<b>U41</b>
With TC: CJC external with fixed value, specify in plain text	<b>Y50</b>
Special differing customer-specific programming, specify in plain text	<b>Y09</b>
Fail-safe value 3.6 mA (instead of 22.8 mA)	<b>U36</b>

Accessories	Article No.
<b>Modem for SITRANS TH100, TH200 and TR200 incl. SIPROM T parameterization software</b> ▶	<b>7NG3092-8KU</b>
With USB connection	
<b>CD for measuring instruments for temperature</b> ▶	<b>A5E00364512</b>
With documentation in German, English, French, Spanish, Italian, Portuguese and SIPROM T parameterization software	

▶ Available ex stock.

◆ We can offer shorter delivery times for configurations designated with the Quick Ship Symbol ◆. For details see page 9/5 in the appendix.

- Here, you enter the initial and final value of the desired measurement range for customer-specific programming for RTD and TC.
- Text on front label not stored inside transmitter.

Supply units see Chapter 7 "Supplementary Components".

### Ordering example 1:

7NG3032-0JN00-Z Y01+Y17+Y29+U03  
Y01: 0...100 C  
Y17: TICA123  
Y29: TICA123

### Ordering example 2:

7NG3032-0JN00-Z Y01+Y17+Y23+Y29+U25+U40  
Y01: 0...600 C  
Y17: TICA123  
Y23: TICA123HEAT  
Y29: TICA123HEAT

### Factory setting:

- Pt100 (IEC 751) with 3-wire circuit
- Measuring range: 0 ... 100 °C (32 ... 212 °F)
- Fault current: 22.8 mA
- Sensor offset: 0 °C (0 °F)
- Damping 0.0 s

# Temperature Measurement Transmitters for rail mounting

**SITRANS TR200**  
two-wire system, universal

## Dimensional drawings

2

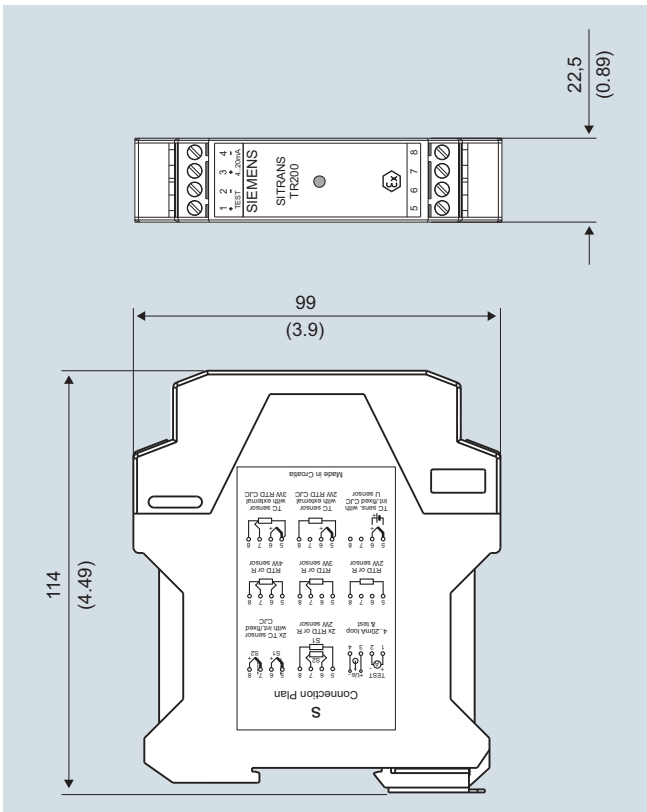

SITRANS TR200, dimensions in mm (inch)

## Schematics

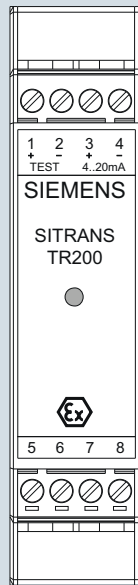

### Assignments

- 1 (+) and 2 (-) Test terminals (test) for measurement of the output current with a multimeter
- 3 (+) and 4 (-) Power supply  $U_{aux}$ , output current  $I_{out}$
- 5, 6, 7 and 8 Sensor assignment, see schematics

SITRANS TR200, pin assignment

# Temperature Measurement Transmitters for rail mounting

SITRANS TR200  
two-wire system, universal

2

### Resistance thermometer

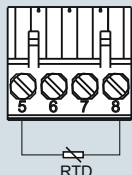

Two-wire system <sup>1)</sup>

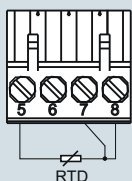

Three-wire system

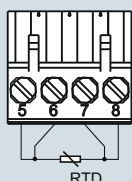

Four-wire system

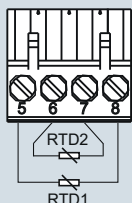

Generation of average value/difference <sup>1)</sup>

<sup>1)</sup> Programmable line resistance for the purpose of correction.

### Resistance

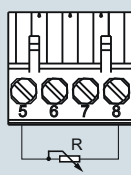

Two-wire system <sup>1)</sup>

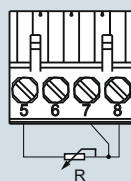

Three-wire system

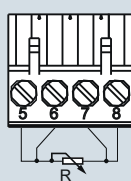

Four-wire system

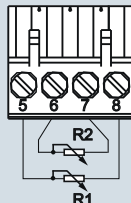

Generation of average value/difference <sup>1)</sup>

### Thermocouple

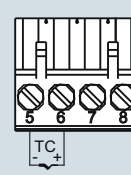

Cold junction compensation internal/fixed value

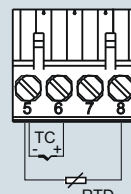

Cold junction compensation with external Pt100 in two-wire system <sup>1)</sup>

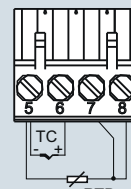

Cold junction compensation with external Pt100 in three-wire system

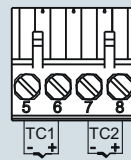

Generation of average value / difference with internal cold junction compensation

### Voltage measurement

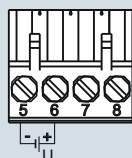

### Current measurement

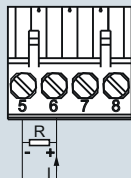

### Test terminals

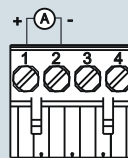

### Power supply/ 4 ... 20 mA (U<sub>aux</sub>)

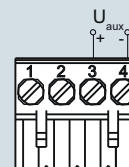

SITRANS TR200, sensor connection assignment