

MeiStream Plus

Class C Bulkmeter for cold potable water DN 40...150 PN 16



Main characteristics

- Meter with MID pattern approval acc. to annex MI001
- Exchangeable metrological unit with MID pattern approval acc. to annex MI001
- Unique measuring range; $Q_3/Q_1 \geq 315$ in horizontal installation
- High overload capability
- No straight inlet length necessary (U0D0 acc. to OIML R49 and EN 14154)
- Meter body in short (WP) and long (WS) overall length acc. to DIN 19625 and EN 14154 available
- Meter can be submerged; protection class IP68
- Used materials are temperature resistant up to 70 °C
- Register prepared for HRI-Mei pick-up
- Use of optical pulsers type OD is still possible

Applications

- Measurement for billing of cold potable water up to 50 °C
- Measurement of medium and high flowrates
- Measurement of low flow e. g. in light load periods
- For leakage control

Available options

- HRI-Mei factory mounted
- Version for use in hazardous area
- ¼" pressure monitoring port
- Encoder register with different data protocols

Approval Mark

Meter cpl. and exchangeable metrological unit

Marking CE M-XX* 0102

DE-09-MI001-PTB 012

* year of production

Performance Data

Metrological Data acc. to Manufacturers Values

	Size	DN	40	50	65	80	100	150
Q ₅	Max. Peak Flow	m ³ /h	50	55	60	120	160	400
Q ₃ '	Continuous Flow	m ³ /h	30	35	40	63	100	250
Q ₂	Transitional Flowrate horizontal acc. to MID	m ³ /h	0.13	0.13	0.16	0.25	0.4	0.63
Q ₁ '	Minimum Flow horizontal	m ³ /h	0.08	0.07	0.1	0.13	0.2	0.35
	Starting Flow	m ³ /h	0.03	0.03	0.035	0.04	0.065	0.12

Metrological Data acc. to 2014/32/EU (MID)

	Size	DN	40	50	65	80	100	150
Q ₄	Overload Flowrate acc. to MID	m ³ /h	31.25	31.25	50	78.75	125	312.5
Q ₃	Permanent Flowrate acc. to MID	m ³ /h	25	25	40	63	100	250
Q ₂	Transitional Flowrate horizontal acc. to MID	m ³ /h	0.13	0.13	0.16	0.25	0.4	0.63
Q ₁	Minimum Flowrate horizontal acc. to MID	m ³ /h	0.08	0.08	0.1	0.16	0.25	0.4
Q ₃ /Q ₁	max. Ratio		315	315	400	400	400	630
Q ₃ /Q ₁	Standard Marking		315	315	315	315	315	315
Δp	Headloss at Q ₃ acc. to EN 14154	bar	0.09	0.08	0.17	0.07	0.16	0.14

Dial

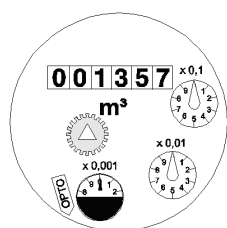

DN 40...100

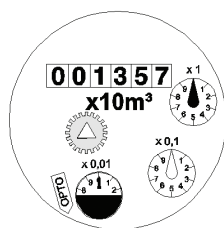

DN 150

Nominal diameter DN	Smallest reading m ³	Max. reading m ³
40 ... 100	0.0005	999,999.999
150	0.005	9,999,999.99

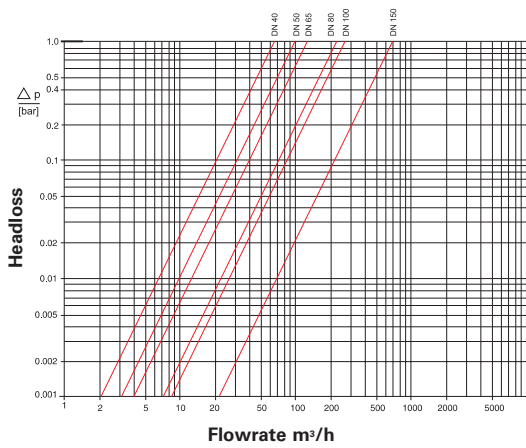

Typical Headloss



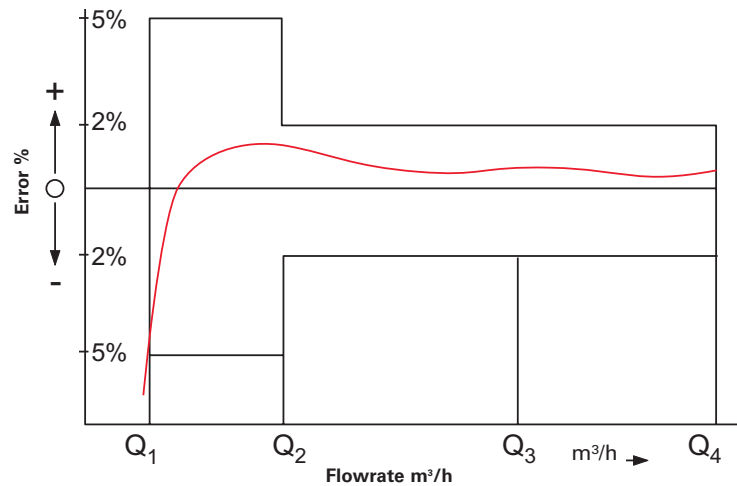

Typical Error Curve



Pulse Values

Pulsar Type		DN 40 ... 100	DN 150
HRI-Mei (Leaflet see LS 8400)		0.01; 0.05; 0.1 or 1 m^3	0.1; 0.5; 1 or 10 m^3
OD 01 (Leaflet see LB 8300)		0.001 m^3	0.01 m^3
OD 03 (Leaflet see LB 8300)		0.01 m^3	0.1 m^3

Installation

Pipe	horizontal	
Meter head	upwards	

Installation Requirements

- Unrestricted straight pipe upstream $0 \times DN$
- No abrupt restrictions directly downstream of the meter

Materials

Body	Cast iron
Measuring element	Plastic
Rotor	Plastic
We also use the following materials	Brass Stainless steel

Available Lengths

Nominal diameter		40	50	65	80	100	150
Overall length L WS (DIN / ISO)	mm		270 / 300	300	300 / 350	360 / 350	500
Overall length L WP (DIN / ISO)	mm	220	200	200	225 / 200	250	300

Dimension Picture

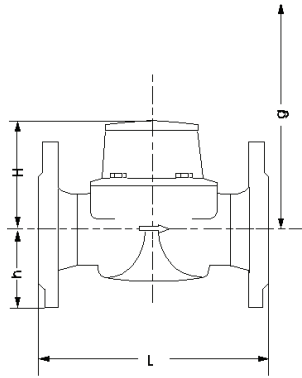

Dimension and Weights PN 16

Nominal diameter			40	50	50	50	65	65	80	80
Dimensions	Overall length	L mm	220	200	270	300	200	300	200	225
	Height	H mm	120	120	120	120	120	120	150	150
		h mm	69	73	73	73	85	85	95	95
	Dismantling height	g mm	200	200	200	200	200	200	270	270
Weights	Meter cpl.	kg	7.5	7.8	9.6	9.9	10.1	12.0	13.8	14.2
	Measuring insert	kg	1.5	1.5	1.5	1.5	1.5	1.5	3.2	3.2
	Body	kg	6.0	6.3	8.1	8.4	8.6	10.5	10.6	11.0

Nominal diameter			80	80	100	100	100	150	150
Dimensions	Overall length	L mm	300	350	250	350	360	300	500
	Height	H mm	150	150	150	150	150	177	177
		h mm	95	95	105	105	105	135	135
	Dismantling height	g mm	270	270	270	270	270	356	356
Weights	Meter cpl.	kg	16.3	17.7	18.2	20.0	20.2	35.9	44.2
	Measuring insert	kg	3.2	3.2	3.2	3.2	3.2	5.9	5.9
	Body	kg	13.1	14.5	15.0	16.8	17.0	30.0	38.3

Order Information

MeiStream Plus, DN 50, T50, PN16
 Drilling EN 1092 PN16
 Length 270 mm
 mechanical register / m³
 with MID conformity

Type
 Size
 Max. medium temperature
 Nominal pressure
 Drilling pattern
 Body length
 Register type / unit
 Approval standard



qualityaustria
 Succeed with Quality

Certified according to ISO 9001
 Quality Management System Quality Austria Reg.no. 3496/0



UK & Ireland Enquiries

Sensus UK Systems Ltd, 3 Lindenwood Crockford Lane, Chineham Business Park
 Basingstoke RG24 8QY UK
 T: +44 (0) 1256 372800 F: +44 (0) 1256 707203 Email: info.gb@sensus.com www.sensus.com

International Enquiries

Sensus GmbH Hannover, Meineckestraße 10, D-30880 Laatzen Germany
 T: +49 (0) 5102 74-0 F: +49 (0) 5102 74-3341 Email: info.int@sensus.com www.sensus.com